



*Quality is the
Measure of Success*

*pure
perfection*

Frenco Brochures

A Frenco Main Catalogue

High Precision Gears and Splines H

- HH** Gear and Spline Manufacture
- HPL** INO-System Spline Gauges and Special Designs
- HPN** IC-Gear Artefacts
- HPR** Master Gears for all Requirements
- HWS** Profiled Clamping System

Instruments for Size Inspection Series V

- VA** Measuring Instruments Rocking Type
- VD** Variable 3-Disc Indicating Gauges VD
- VK** Measuring Pins and Measuring Ball Inserts
- VM** Spline Measuring Instruments VM with Guiding Profile
- VP** Gear Testing Instruments VP with Face Stop
- VY** Special Inspection Instruments

Rotation Measuring Systems R

- RK** Universal Rotation Measuring Instruments with Measuring Circles
- RM** Multiple Inspector
- RWL** Linear Gear Flank Analyser Rack
- RWS** Gear Flank Analyser
- RWZ** Double Flank Gear Roll Inspection Machines

Gear & Spline Inspection P

- P** Gear and Spline Inspection

Know-How-Transfer K

- KD** OF-Documents
- KE** Effity- Game to learn
- KP** Spline Standards and Spline Calculation

The latest version of the individual brochures are available for download here:
www.frenco.de/download/brochures

Frenco Company Profile 4

The future is already our strength	4
Perfection in detail is only achieved by analysing the whole	5
Experts at work	6



Ultra-High Precision H 9

Gear Artefacts, IC Gear Artefacts	11
Setting Masters, Spline Gauges	14
Master Gears	16
Profiled Clamping Systems	17
Gear Forming Tools	18
Gear and Spline Manufacture	19



Instruments for Size Inspection V 21

Measuring Pins and Ball Inserts	26
Instruments, Rocking Type	27
Instruments with Face Stop	28
Instruments with Guiding Profiles	31



Rotation Measuring Systems R 39

Instruments with Measuring Circles	43
Multiple Inspector	45
Linear Gear Flank Analyser Rack	49
Double Flank Gear Roll Inspection	51
Gear Flank Analyser	59



Gear & Spline Inspection P 65

Monitoring of Inspection Equipment	68
Workpiece Inspections	69
Online Inspection Certificate	70
DAkS-Calibration	71
VDA-5-Certificate	73
Analysis of Deviations	74
“All-Tooth-Measurement“ with REANY Evaluation	75



Know-How-Transfer K 77

Software	78
Training, Seminars and Workshops	82
Consulting and Calculations	84
Literature and Documentations	86



Our mission is to supply tomorrow's demands today

Future-orientated technologies make great demands on the quality of gears and splines. FRENCO is committed to the full spectrum of quality assurance for all types of gears and splines. Often, standard solutions do not meet the requirements of highly sensitive and complex components and systems. Specialisation, innovative developments and individual solutions

are required. FRENCO adopted this strategy from the beginning.

Production Metrology for Gears and Splines

Since 1978, FRENCO has developed from a manufacturer of simple measuring equipment for splines to a system

supplier and specialist in the complex area of process integrated quality assurance of gears and splines. The company focuses on flexibility and is open to discussions, ideas and new ways. Basic research, cooperation with institutes and as well as collaborating with partner companies, combined with internal expertise are the foundations for a future-oriented technology.

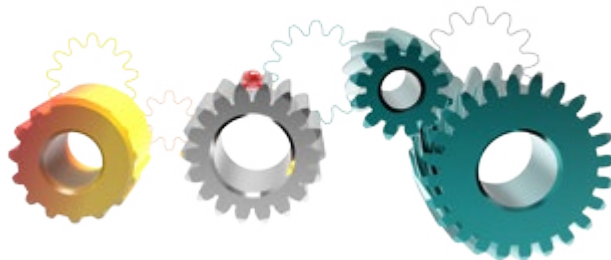

pure
perfection

Perfection in detail is only achieved by analysing the whole

The individual tasks of inspecting gears and splines vary considerably. It is often a very easy process, but can also be a highly complex task from a mechanical or software point of view.

FRENCO: *Knowledge Leader*

From selecting suitable gears and splines and determining the conditions of compatibility to optimum inspection methods.

Through training and seminars, FRENCO provides comprehensive technical knowledge more profound and qualified than is currently taught at training institutes.

Perfection in detail is only achieved by analysing the whole. This requires both a thorough analysis of the task and consideration of all preceding and subsequent processes.

Tooth profile measuring technology is created from many available technical

designs (many of which are patented FRENCO developments) and from new concepts and developments – guaranteeing practical functionality and high efficiency.

FRENCO: *Technology Leader*

We are engaged in updating and extending technical directives and national and international standards. In this respect our targets go far beyond today's standards.



FRENCO is represented in these committees and organizations.



Experts at work

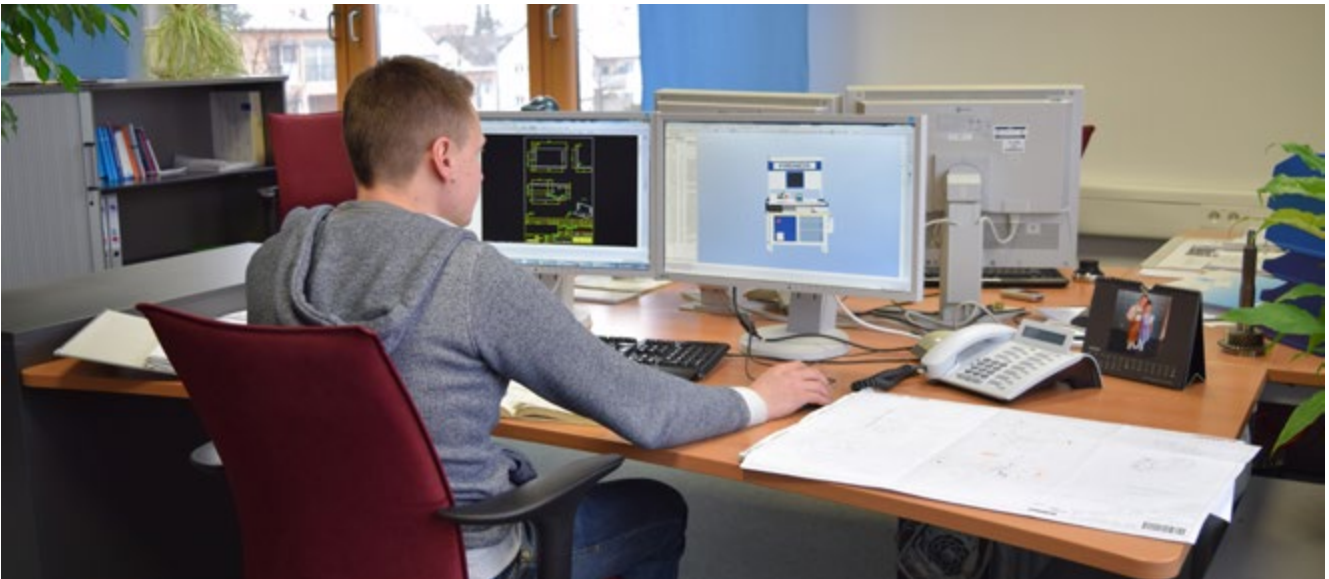

pure
perfection



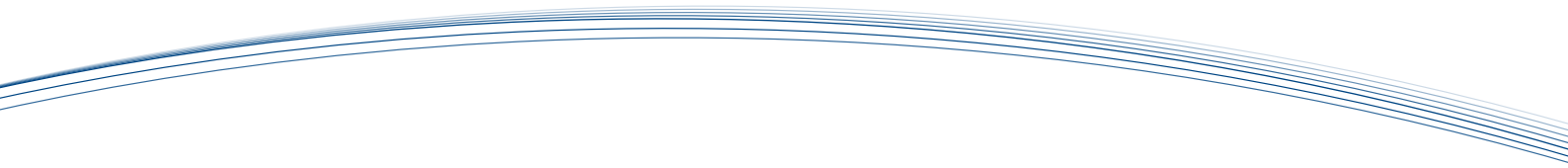

Ultra-High Precision for Inspection Equipment, Tools and Prototypes

H

Gear Artefacts, IC Gear Artefacts
Setting Masters, Spline Gauges
Master Gears
Profiled Clamping Systems
Gear Forming Tools
Gear and Spline Manufacture



Assured Quality
- certified

pure
perfection

Ultra-High Precision - Gears and Splines

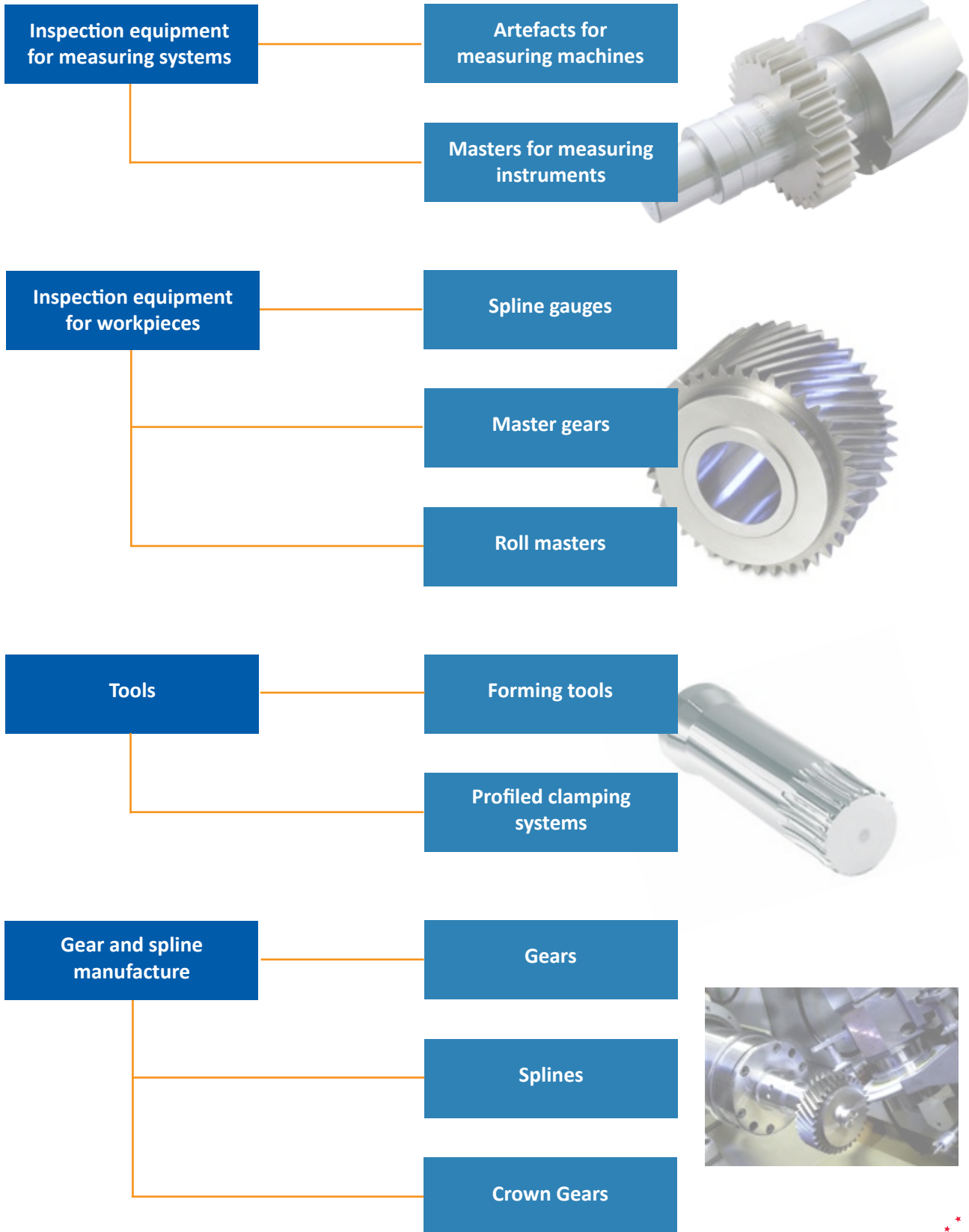

H

Artefacts

Artefacts should have a geometry similar to that of the specimens (=Identity Condition)



IC Artefacts

The design of conventional artefacts is very different from that of the specimens. There is no similarity, not to mention an identity condition.

IC artefacts can be designed with a similar profile to that of the workpieces to be tested. This is necessary in order to be able to estimate the measuring uncertainty when specimens are inspected on gear measuring machines.

IC artefacts can be designed in a number of ways. They can be manufactured for running gears, internal and external gearing with different modules and pitch circle diameters as well as for splines. Their geometrical size can be made to suit small plastic gears and HGV gears.



Artefacts should feature all important gear and spline characteristics



Artefact combinations

Conventional artefacts for gears and splines are individual profile-, helix- or pitch artefacts. Their significance is very restricted.

IC artefact combinations enable the determination of the measurement uncertainty of all important gearing characteristics.

Spur gears	+	Helical gears
Sector gears	+	Composite gears
Left flank	+	Right flank
One space width	+	Opposite space widths
Even number of teeth	+	Odd number of teeth

Profile deviation:	For spur and helical gears with left and right hand helix angles.
Helix deviation:	For spur and helical gears with left and right hand helix angles.
Pitch deviation:	For single and cumulative pitch.
Runout deviation:	For runout, position of axis and roundness.
Dimension over balls:	For odd and even numbers of teeth.

Artefact A

- Profile
- Helix
- Dimension over balls



Artefact B

- Profile
- Helix
- Pitch
- Runout
- Dimension over balls



Combination Artefact A/B

- „All-in-one“
- Modular
- Lower Cost



Artefact C

- Profile
- Helix
- Dimension over balls



Artefact D

- Profile
- Helix
- Pitch
- Runout
- Dimension over balls

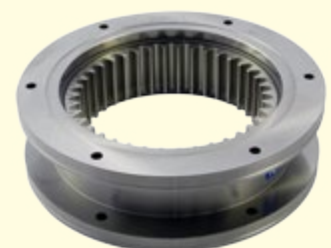





H

Modification artefact M

- Crownings
- Reliefs
- Angle deviations
- Waviness
- Pitch deviations



H

		 	
akkreditiert durch die / accredited by the			
Deutsche Akkreditierungsstelle GmbH			
als Kalibrierlaboratorium im / as calibration laboratory in the			
Deutschen Kalibrierdienst 			
Kalibrierschein Calibration certificate		Kalibrierzeichen Calibration mark	
		000789	
		D-K-	
		15199-01-00	
		2015-03	
Gegenstand Object	IC-Artefact A/B für Profil, Flankenlinie, Teilung, Rundlauf und M_{sk}	Dieser Kalibrierschein dokumentiert die Rückführung auf nationale Normale zur Darstellung der Einheiten in Übereinstimmung mit dem Internationalen Einheitensystem (SI).	
Hersteller Manufacturer	FRESCO GmbH Jakob-Baier-Straße 3 90518 Altdorf	Die DAKKS ist Unterzeichnerin der multilateralen Übereinkommen der European co-operation for Accreditation (EA) und der International Laboratory Accreditation Cooperation (ILAC) zur gegenseitigen Anerkennung der Kalibrierscheine. Für die Einhaltung einer angemessenen Frist zur Wiederholung der Kalibrierung ist der Benutzer verantwortlich.	
Typ Type	d = 105.000 mm; β = 0°, 20° r + l	This calibration certificate documents the traceability to national standards, which realize the units of measurement according to the International System of Units (SI).	
Fabrikat/Serien-Nr. Serial number	04711 00 01 00	The DAKKS is signatory to the multilateral agreements of the European co-operation for Accreditation (EA) and of the International Laboratory Accreditation Cooperation (ILAC) for the mutual recognition of calibration certificates.	
Auftraggeber Customer	Musterkunde	The user is obliged to have the object recalibrated at appropriate intervals.	
Auftragsnummer Order No.	20154711		
Anzahl der Seiten des Kalibrierscheines Number of pages of the certificate	7		
Datum der Kalibrierung Date of calibration	16.03.2015		
Dieser Kalibrierschein darf nur vollständig und unverändert weiterverbreitet werden. Auszüge oder Änderungen bedürfen der Genehmigung sowohl der Deutschen Akkreditierungsstelle GmbH als auch des ausstellenden Kalibrierlaboratoriums. Kalibrierscheine ohne Unterschrift haben keine Gültigkeit.			
This calibration certificate may not be reproduced other than in full except with the permission of both the Deutsche Akkreditierungsstelle GmbH and the issuing laboratory. Calibration certificates without signature are not valid.			
Datum Date	Leiter des Kalibrierlaboratoriums Head of the calibration laboratory	Bearbeiter Person in charge	
18.03.2015	Dipl. Ing. (FH) J. Kühl	J. Stellwag	
Fresco GmbH Verzahnungstechnik DAKKS Kalibrierlaboratorium für Verzahnungsmessgrößen Jakob-Baier-Str. 3 – 90518 Altdorf Tel. +49(0)9187 9522-0 – Fax. +49(0)9187 9522-40 Internet www.fresco.de – E-Mail info@fresco.de			

DAkKS (Deutsche Akkreditierungsstelle GmbH- German Accreditation Body) calibration certificates are currently issued for IC artefacts A, B and Bm as well as for conventional artefacts type 100, in line with the accredited parameters.

DAkKS calibrated artefacts ensure the traceability to the SI unit “metre” and form part of the traceability chain to the national artefact.

The following parameters are calibrated, depending on the design:

- Profile deviation
- Tooth trace deviation
- Pitch deviation
- Runout deviation
- Dimension over balls

Masters for Measuring Instruments

Setting masters are used to calibrate instruments for size inspection. Their tooth form is identical to that of the specimen. Setting masters are usually of the sector type with just two tooth spaces. However, multiple point measurement instruments (Frenco VM nx2) require composite setting masters.

Setting masters with the actual size near the tolerance limit are sufficient, if size inspection instruments are used with mechanical dial gauges or dial indicators. If electronic display units and computers are used, a set of setting and control masters is recommended, to ensure that the electronic spread and the mechanisms are also monitored.

Inspection masters are recommended for all profiled clamping systems. They are used to monitor function and accuracy.

Acceptance masters are used to calibrate inspection systems.



Setting masters for calibration



Control master to monitor measuring instruments



Inspection master for clamping systems



Acceptance master for inspection systems

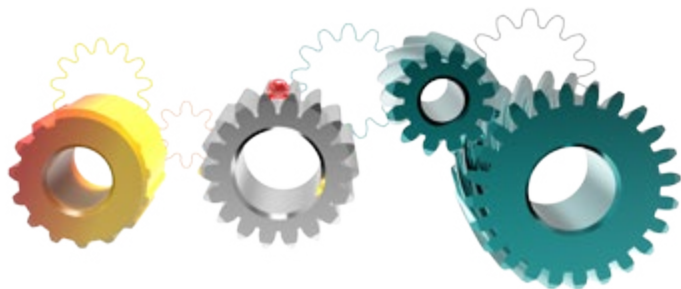

Spline Gauges

Spline gauges are described in several national, foreign and in the international standard ISO 4156. All these standards differ from one another.

The FRESCO INO system for spline gauges represents a unified standard at the highest technical level.

Spline gauges are available in various designs. For further details see brochure HPL "Spline Gauges".

Plug Gauges Go & No Go



Involute

Ring Gauges Go & No Go



Involute



Serration



Serration



Straight sided



Straight sided

H

Master Gears

Master gears are available for single and double flank gear rolling inspection and can be designed according to

not according to a standard. FRENCO offers various designs. Even the most stringent requirements can be fulfilled.

Standard

- Quality class B or C
- Chrome steel CSP (low-corrosion)
- Base body in accordance with DIN 3970
- Uncoated, no modifications



Extras

- Quality class A
- High alloyed powder steel SX
- Tip chamfers
- PVD coatings (Quality class B or C)
- Modifications



Special

- Master worms, master pinion gears
- Internal master gears
- Customized base bodies
- Modules smaller than 0.3 mm
- Special coatings









H

Profiled Clamping Systems

Clamping systems secure workpieces in the gear profile where they are centered and clamped in the tooth flanks. Both testing operations as well as machining processes are possible relative to the tooth flank datum. Arbors are used for internal gearing and chucks

for external gearing. The constructive design of these clamping devices is diverse in its implementation. Various clamping methods may be suitable depending on the task at hand. Selection of the most appropriate methods requires expertise and knowledge.

Both are offered by the FRENCO specialists as a consequence of their many years of research and experience. The basic definition of the clamping methods should only be undertaken by specialists.

Manufacturing clamping technology	for internal gears	One-flank taper mandrels	
		Hydraulic arbors	
		Mechanical systems	
		Spring sleeve systems	
	for external gears	Concentricity rings	
		Bevel gear nests	
Inspection clamping technology	Individual solutions		



Forming Tools

Profiled punches and dies are used in the non-cutting manufacture of gearing. The accuracy of these tools is transferred directly to the workpiece.

Size allowances are incorporated into the tool to accommodate shrinkages. The given spark gaps for electrodes

are maintained. Electrodes can be made from copper or graphite.

H

Spur and helical gearing



Forming punch

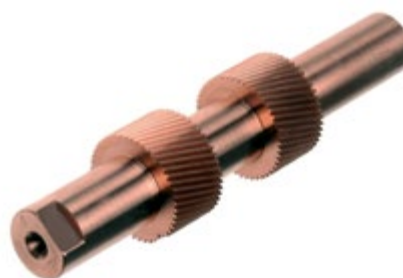

Roughing and finishing electrode

External and internal gearing



Toothed matrix



Smoothing gears

Gear and Spline Manufacture

FRENCO produces gears and splines made to specification and in small batches. Gears and splines with qualities greater Q5 are difficult to produce with normal methods and manufacturing equipment. FRENCO commercial-manufactures spur and helical gearing of qualities DIN Q3 and Q4.



Semi-automatic grinding



CNC grinding of internal profile

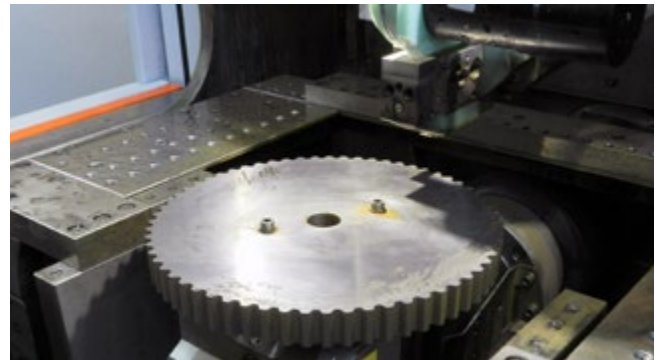

Wire EDM

Max. workpiece length	external gear/spline		750 mm
	internal gear/spline workpiece size wire EDM		300 mm 800 x 350 mm
Max. profile length	external gear/spline		700 mm
	internal gear/spline	for pitch circle up to 30	70 mm
	internal gear/spline	for pitch circle up to 60	110 mm
	internal gear/spline workspace wire EDM	for pitch circle up to 150	150 mm 320 x 220 mm
Max. through bore diameter	Grinding		300 mm
	Wire EDM		220 mm
Max. pitch circle diameter	external gear/spline		450 mm
	internal gear/spline		ca. 250 mm
	wire EDM		ca. 210 mm
Min. pitch circle diameter	internal gear/spline		16-18 mm
Max. part weight			50 kg
Materials	grinding		steel, copper, graphite, titanium
	wire EDM		steel, copper, copper alloys
Gear/spline accuracy	DIN 3962		Q3
	DIN 5480		Q3
Inspection machines	Klingelnberg P40 Mahr Perthometer Mahr Precimar ULM 600-E		

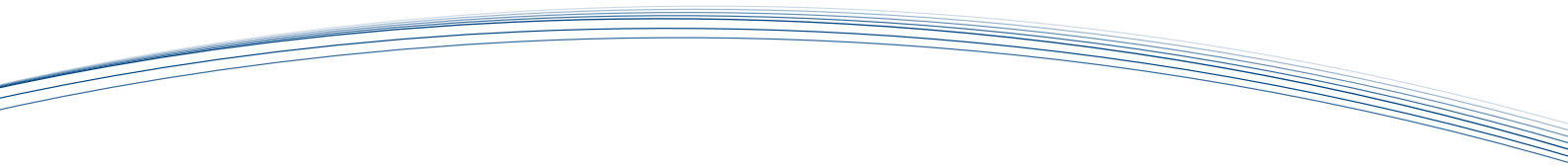

Size Inspection Instruments for the Size Over/Between Balls

Measuring Pins and Ball Inserts
Instruments, Rocking Type
Instruments with Face Stop
Instruments with Guiding Profiles

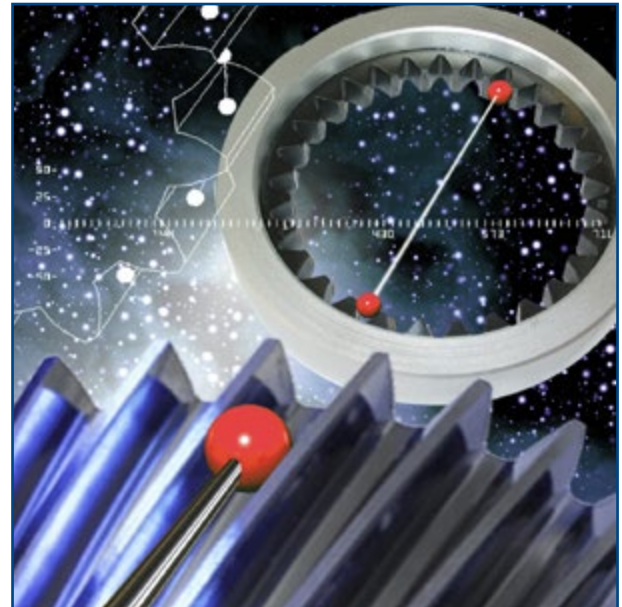

*Reliability and precision
for all requirements*

pure
perfection

Instruments for Size Inspection Series V

Decrease costs, Increase profit

Tailored precision. Improved quality results along with even higher efficiency due to purposeful inspection of individual workpieces.

Superior quality reduces the number of rejects, accelerates procedures and production. Your quality requirements delivered just-in-time.

The foundations for flawless quality...

FRENCO's series V provides state-of-the-art gear and spline inspection instruments: for transmission technology and mechanical engineering. Bespoke and made to suit your specific applications. Precision for the highest of standards.

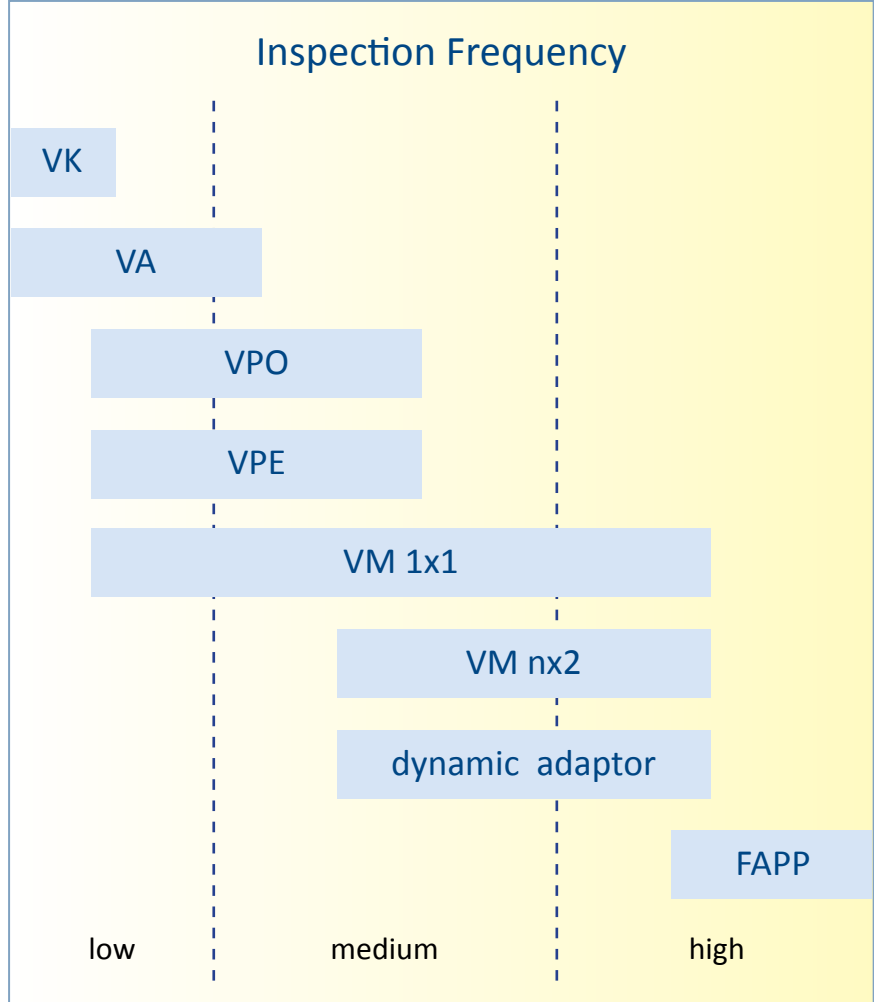

... enhance inspection reliability

Whenever technology is "showing teeth"...
Where uncompromising reliability of profiled connections matters ...
And where both quality and performance are called for in equal measure...
... FRENCO is there. Throughout the world.

... the new dimension, for all quantities

FRENCO provides the programme for success. The right gear inspection instrument for the right application.

individually manufactured - compliant with all standards - "tailored technology" worldwide



type	specification	image
VK	measuring pins and measuring balls	
VA	Instruments, rocking type	
VP	Instruments with face stop	
	Instrument with face stop and vertical travel	
VM 1x1	Instruments with guiding profile	
VM nx2	Instruments with guiding profile and nx2 measuring inserts static or dynamic	
L-Dyn	LDYN longitudinal dynamic software	
FAPP	fully automatic inspection systems	
VD	variable 3-disc indicating gauges	



The VDA 5-Certificate for Instruments Series V

Uncertainty of inspection equipment U_{MS} acc. to VDA 5

An important requirement laid down in many standards and guidelines of both associations and companies in the automotive industry is the verification of the suitability of the inspection, measuring and test processes.

QS 9000

Monitoring of inspection equipment: Inspection and test equipment capability (11.4)

DIN EN ISO 14253

Standards and guidelines for the inspection by measurement of workpieces and measuring equipment – Decision rules

DIN EN ISO 13005

Determination and expression of uncertainty in measurement

VDA 6.1

Monitoring of inspection equipment: measurement uncertainty (16.3)

FRENCO provides on request

- verification of inspection and test equipment ability for your workpiece (tolerance of size over/between two balls $\geq TOL_{MinUMS}$) and
- the uncertainty contribution of the Frenco inspection instrument (u_{MS}) in determination of the overall uncertainty of your inspection process, on a U_{MP} inspection certificate, based upon VDA 5.

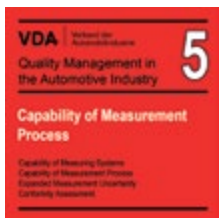

FRENCO GmbH Jakob-Baier-Strasse 3 90518 Altdorf Tel.: +49 9187 9522-0 Fax: -40 www.frenco.de

VDA-5 Certificate		27.09.2013			
acc. to VDA 5 (2. Edition Update 2011)		Inspector: Frenco Prüfer			
Proof of Measurement System Capability					
Drawing No.: 61046 10 00 00	Customer: Musterkunde	20134711			
Part No.: 01	Order number:				
Type: IVMF 1x1	U= 23.4025	L= 23.3483			
TOL= 0,054					
%RE Resolution of indicator u_{RE}					
Resolution: 0,001 (=half scale division)					
Resolution RE in %: 1,8% i.O. => no ure					
If Resolution RE > 5 % than calculate u_{RE}					
		$u_{RE} = 0,00 \mu m$			
Calibration uncertainty u_{CAL}					
Measuring uncertainty of setting-master (ref. certificate):					
Drawing No.: 61046 11 03 00 Teil 01		$u_{CAL} = 1,00 \mu m$			
Repeatability on reference standard u_{EVR}					
25 repeat measurements on setting ring including probe [µm]:					
1..5	0,0	-0,0	-0,1	-0,2	-0,2
6..10	-0,1	-0,1	0,0	0,0	0,0
11..15	0,0	0,0	0,0	0,1	0,1
16..20	0,2	0,3	0,1	0,0	0,1
21..25	-0,1	-0,2	0,1	0,2	0,3
$s_p = 0,138$			C_g C_{gk} without RE acc. to VDA 5 (2.2011):		
Resolution of Probe: 0,0001			$C_g = 19,57$		
Proportion: Resolution / $s_p > 2$?			yes, it follows uwsg 0,03 $C_{gk} = 19,50$		
		$u_{EVR} = 0,14 \mu m$			
Uncertainty from linearity and bias u_{BI}			Resulting from 25 repeat measurements (incl. C_g und C_{gk})		
Normal	Actual value x_n [mm]	Measurement x_m [mm]	Deviation [µm]		
$x_{m=1}$	23,4025	23,4028	0,3		
$x_{m=2}$	23,4025	23,4031	0,6		
$x_{m=3}$	23,4025	23,4031	0,6		
$x_{m=4}$	23,4025	23,4030	0,5		
$x_{m=1}$	23,3754	23,3750	-0,4		
$x_{m=2}$	23,3754	23,3753	-0,1		
$x_{m=3}$	23,3754	23,3755	0,1		
$x_{m=4}$	23,3754	23,3754	0,0		
$x_{m=1}$	23,3483	23,3480	-0,3		
$x_{m=2}$	23,3483	23,3478	-0,5		
$x_{m=3}$	23,3483	23,3479	-0,4		
$x_{m=4}$	23,3483	23,3478	-0,5		
		$u_{BI} = 0,29 \mu m$	$u_{EV} = 0,29$ $u_{EV} = 0,22$		
Uncertainty form dial indicator u_{MS_REST}			$u_{MS_REST} = 0,00 \mu m$		
Expanded uncertainty U_{MS}			$U_{MS} = 2,10 \mu m$		
Capability ratio Q_{MS}			$Q_{MS} = 8\%$		
Minimum possible tolerance $TOL_{MIN-UMS}$			$TOL_{MIN-UMS} = 0,021 mm$		











Resulting from 25 repeat measurements (incl. C_g und C_{gk})

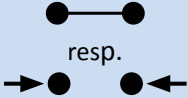
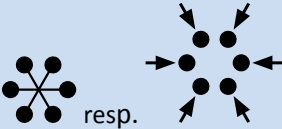

Performance Features

Overview

The different instrument types have different features, which are shown in the following table:

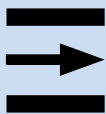
measured value display		dial indicator
		digital data processing
radial measuring points		one pair, opposite internal or external
		several pairs, opposite internal or external
measuring process		manual
		automatic
go gauging		without
		integrated
axial measuring planes		static
		dynamic

The programme of success

Inspection of the diametrical size over/between two balls. Integrated 'go inspection' on request.

- from simple to comprehensive
- from analogue to digital
- from 2 to 6 measuring points
- from static to longitudinal dynamic
- from manual to fully automatic



Measuring Pins and Balls

Measuring pins and balls are used for the dimensional inspection of gears and splines.

Measuring pins are only suitable for the inspection of spur gears.

Measuring pins



Material	Accuracy	Application
Steel	± 0.001 mm	Standard items
Carbide	± 0.001 mm	Precision items
Carbide	± 0.0005 mm	Gauge inspection
Carbide	± 0.0003 mm	Masters and artefacts

Measuring tips



Design	Radius
M2 thread	smaller than 0.75 mm
M2.5 thread (standard)	smaller than 0.75 mm
M3 thread	smaller than 0.75 mm

Carbide measuring balls







Design (Grade 25, 1500 HV)	for ball ϕ
Soldered onto shaft, M 2.5 thread, excl. AF	1 to 7 mm
Soldered onto shaft, M 4 thread, incl. AF	5 to 12 mm
Ball with internal thread M4	10 to 25 mm



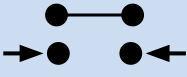

Inspection Instruments Rocking Type

Range of application:

Small and medium sized series. Each measuring point is established by rocking the instrument, until the smallest point of return is found. Profiled setting masters are required. Don't use these instruments for helical gears or splines with odd number of teeth.

measured value display	radial measuring points	go gauging	axial measuring planes	inspection process
				

IVA

title	pitch circle ϕ	image
IVA 0	4 - 15 mm	
IVA 1	15 - 28 mm	
IVA 2	28 - 130 mm	
IVA 3	50 - 330 mm	
IVA 4	greater than 190 mm	

AVA

title	pitch circle ϕ	image
AVAL 1	0 - 35 mm	
AVAL 2	35 - 70 mm	
AVAL 3	70 - 135 mm	
AVAL 4	135 - 180 mm	

Inspection Instrument VPO

measured value display	radial measuring points	go gauging	axial measuring planes	inspection process

The VPO is a simple gear testing machine to determine the diametrical size over two balls in one specific measuring plane.

It can be refitted within a few minutes and is particularly suitable for quick measurements of small pieces up to a PCD of 120 mm.





The balls are mounted on a movable and a fixed carriage. To change the workpiece, the movable carriage can be retracted using the lever on the front.

To display the measuring results both a dial indicator or a digital probe can be used.

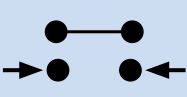

Technical specifications VPO	
External gears	up to 100 mm PCD
Internal gears	up to 120 mm PCD
Measuring force	infinitely adjustable up to 10 N
Dimensions (without stilts)	185x180x58 mm
Weight approx.	3.3 kg

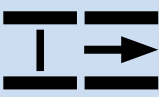
Inspection Instrument VPE

measured value display	radial measuring points	go gauging	axial measuring planes	inspection process
				

The VPE is a gear testing machine to determine the diametrical size over two balls in any number of planes. It can be refitted within a few minutes and is mainly used for quick measurements of pieces with a PCD up to approx. 220 mm.



Technical specifications	
External gears	up to 200 mm PCD
Internal gears	up to 220 mm PCD
Vertical travel	30 mm
Measuring force	infinitely adjustable up to 10 N
Dimensions (without stilts)	340x118x210 mm
Weight approx.	11 kg



Inspection Instrument VPOS

measured value display	radial measuring points	go gauging	axial measuring planes	inspection process

The VPOS instrument was designed to measure the dimension over/between balls on large workpieces and splined shafts.

Great importance was given to functionality, optical characteristic and easy handling to ensure that, besides precision and accuracy, a comprehensive objective was achieved. The positioning of the stilts is performed pneumatically, and the feed mechanically dampened. To increase safety, the device can be operated in two-hand mode. The measuring force can be adjusted to the workpiece weight quickly and easily via the lever.

The VPOS is easy to operate and a stable table-top instrument to be used on the shop floor.

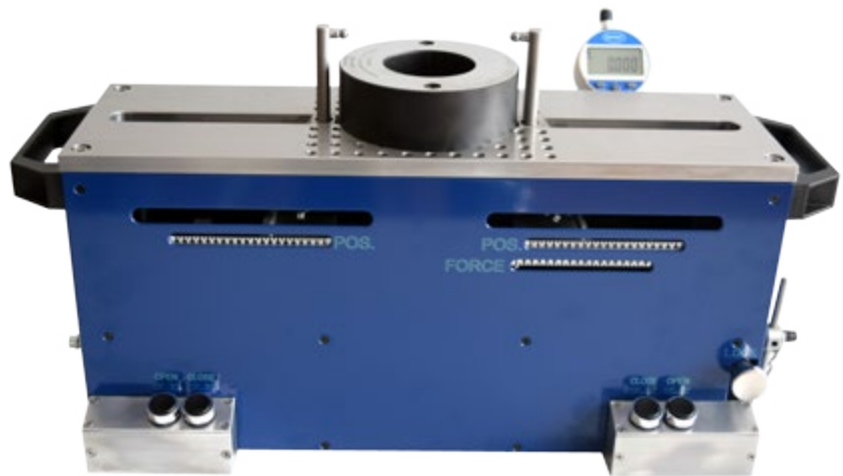





Technical specifications	
External gears	Dimension over balls: 75- 260 mm
Max. shaft diameter	up to $\varnothing 60$ mm (in standard version)
Max. shaft shoulder length	up to 108 mm (extendable)
Measuring force	infinitely adjustable up to 15 N
Dimension (without stilts)	340x210x118 mm
Weight approx.	25 kg

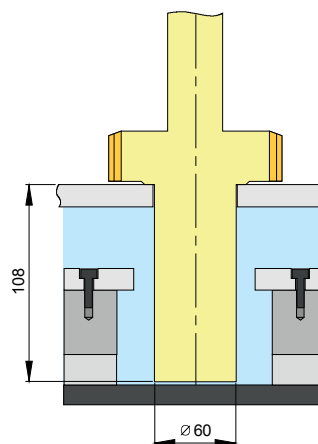

Lever to infinitely adjust the measuring force



Inspection Instrument AVM 1x1

measured value display	radial measuring points	go gauging	axial measuring planes	inspection process
				

AVM 1x1 instruments have a profiled guidance ring, a measuring insert with two carbide measuring balls and come with either a dial indicator or a digital measurement display. The guiding profile can also be supplied as go gauge.





A measuring stand is also available for simplified handling: The AVM 1x1 instruments are usually used for measuring medium-sized workpiece batches.



AVM 1x1 with dial indicator and measuring stand

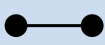

Inspection instrument IVM 1x1

measured value display	radial measuring points	go gauging	axial measuring planes	inspection process
				

IVM 1x1 have a profiled guidance plug, a measuring insert with two carbide measuring balls, a handle or a measuring stand and a dial indicator or a digital display. Both measuring ball inserts are mechanically connected.

The guiding profile can also be supplied as go gauge.

IVM 1x1 are mainly used for the measurement of medium-sized batches.



IVM 1x1 with handle and dial indicator

Inspection Instrument AVM nx2 K

measured value display	radial measuring points	go gauging	axial measuring planes	inspection process
88				

AVM 1x2 K	AVM 2x2 K	AVM 3x2 K

All VM nx2 measuring instruments from Frencos have multiple measuring inserts. To determine the diametrical size over two balls, two inductive probes (located opposite each other) are added together.

The types nx2 K use carbide measuring ball inserts, which are screwed into the inductive probes. Worn measuring balls can be replaced.





Due to the major wear of the measuring balls, the measuring instruments VM nx2 K are only suitable for small and medium-sized batches. Larger batches or hardened workpieces are best inspected with VM nx2 RS instruments, which work with radius disks.



Type AVM nx2 K with longitudinal dynamic adapter on measuring stand with setting master and control plug

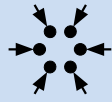

Inspection Instrument AVM nx2 RS

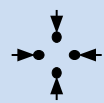
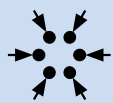
measured value display	radial measuring points	go gauging	axial measuring planes	inspection process
				
AVM 1x2 RS	AVM 2x2 RS	AVM 3x2 RS		
				

AVM nx2 RS instruments are working with radius disks and not with measuring balls. They are clamped in a floating insert and can be turned. The wear of radius disks is much lower than that of measuring balls. Thanks to the option of turning the disks, wear does not pose a problem. AVM RS measuring instruments have a simple design, are very robust and easy to handle.

RS instruments are suitable for automation. They are therefore particularly suitable for large series, before and after hardening.

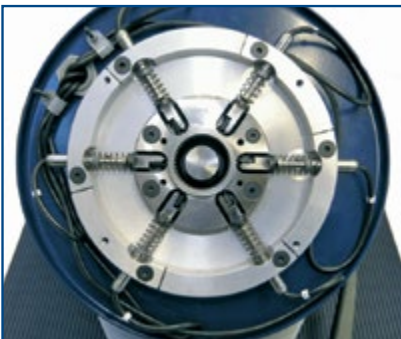



AVM 3x2 RS:
3x2 floating inserts with radius disk





Typ AVM nx2 RS with longitudinal dynamic adapted on measuring stand



Inspection Instrument IVM nx2 RS

measured value display	radial measuring points	go gauging	axial measuring planes	inspection process
				

AVM 1x2 RS	AVM 2x2 RS	AVM 3x2 RS
		

Measuring instruments with multiple measuring points for the measurement of the size between balls require, due to their limited space, some clever engineering. That is why IVM nx2 are always equipped with radius disks. The radius disks are mounted on floatingly suspended measuring levers. They are turnable if the clamping is loosened.

IVM nx2 RS are suitable for automation with FAPP-Systems.



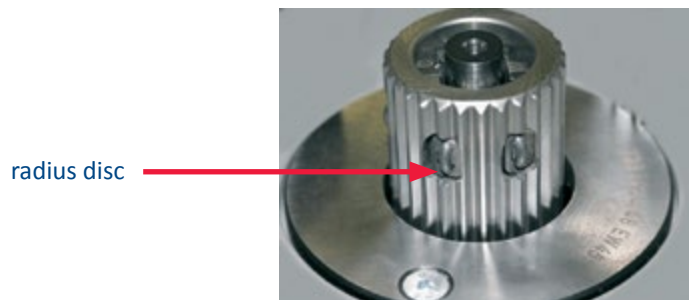

Typ IVM nx2 RS with longitudinal dynamic adapter



radius disc

Tripod Inspection instrument IVM 3x1 K

measured value display	radial measuring points	axial measuring planes	inspection process
88			

IVM 3x1 K is used to measure tripod ball tracks. This version is only available with a longitudinal dynamic adapter. To guarantee a best possible adaption in the ball track, the three ball insert pairs are clamped in a floating insert.

The measuring inserts for gothic contours have two-point contact. Those for the ball tracks have single-contact.



IVM 3x1 K with dynamic adapter,
Tripod with gothic contour



Measuring head with measuring ball inserts and distance bolt

Measurement Software L-Dyn

All gear testing instruments with adapter are suitable for dynamic measurements. The travel of the table or the bars is assigned to one measurement reading and recorded. The workpiece can therefore be measured in hundreds of planes and the values can be evaluated on a PC.

The measurement enables the determination of the dimension over balls and the evaluation of the following values:

- tapering
- crowning
- roundness

Interfaces for your database and QS-Stat are available.

Furthermore, the data can be exported to Excel. It is therefore possible to evaluate several data sets. When a workpiece is measured before and after hardening, the quenching distortion can also be determined.

When a measurement is complete the values are marked in colour:

- green:** Measured value within accepted tolerance
- yellow:** Measured value outside intervention limits
- red:** Measured value outside accepted tolerance

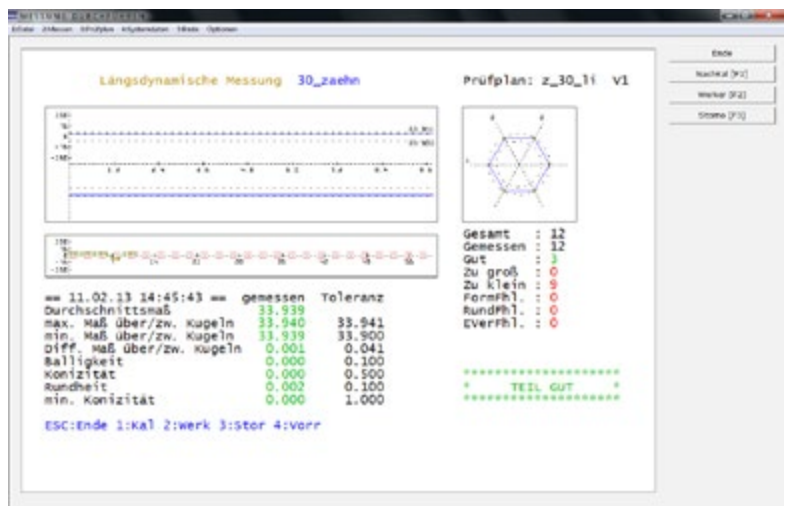

Workbench Set-Up

L-Dyn systems reach pure perfection when they are set up on a FRENCO workbench: the wiring and electronic systems are securely and invisibly stored away and the control masters are protected against damage in the drawers.



Fully Automated System FAPP

Our FAPP system enables automatic inspections of internal and external splines. Integrated in a production line, a cycle time of about 10 s can be achieved.

All FRENCO gear inspection machines type VM nx2 RS can be automated with the FAPP-System.

The FAPP-Systems are designed as autonomous units. They are equipped with a pneumatic and electric control for the motion processes of the fitting unit and that of the linear feed. Interfaces for the communication with handling machines are standard. Further interfaces are optional.

FRENCO also offers complete FAPP inspection cells with integrated handling systems and sorting units.



Variable 3-Disc Indicating Gauges VD

Circumferential backlash measuring instruments have three composite profile discs. The two outer discs are rigid while the middle disc can be easily rotated by means of spring force. This causes a change in the tooth position, which is shown by a dial indicator or an inductive probe.

The measuring instrument is set to zero using a composite setting master, which embodies the limit of an effective spline. The distance of rotation is then shown in comparison to the setting master. The actual position of the effective spline within the tolerance zone can now be assessed.

This value allows the stability of the manufacturing process with regards to the overlay of individual geometry errors to be monitored.

To analyse the mounting forces, the effective spline, as measured with this instrument, must be combined with the actual dimensions.

FRENCO also offer software for this purpose. It determines the difference between actual and effective and offers important information with regard to the

- press capacities
- quality of the gearing
- overlay of individual form errors

Circumferential backlash measuring instruments are always offered with setting master and check master to verify the shown distance of rotation. This is to ensure the plausibility of the results.



IVD



AVD

Every gauge is delivered with a setting and control master.

Rotation Measuring Instruments for Measuring Results All Around

Instruments with Measuring Circles
Multiple Inspector
Double Flank Gear Roll Inspection
Gear Flank Analyser



R

*More information
for greater validity*



pure
perfection

The Product Range

Rotation measuring instruments are based on one or two rotational axes. Simple solutions for rotation-symmetric specimens are achieved when combined with one or two linear axes.

Whether manual or automatic, horizontal or vertical, the areas of application are versatile and flexible. Rotation measuring devices are usually posi-

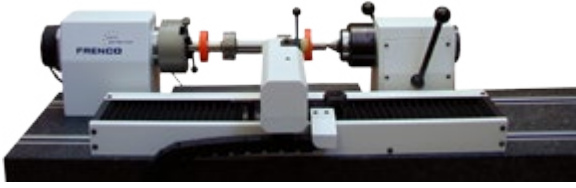
oned directly in the manufacturing environment and reduce the workload of the measuring machines in the inspection room.

type	specification	image
URM HGM	horizontal with tip center manual	
URM HGAL	horizontal with tip center automatic light	
URM HGAS	horizontal with tip center automatic heavy	
URM VA	vertical automatic	

R

<p>RM horizontal</p>	<p>multiple inspector</p>	
<p>RM vertikal</p>	<p>multiple inspector</p>	
<p>RWL rack</p>	<p>double flank gear roll inspection of racks</p>	
<p>ZWP 06</p>	<p>double flank gear roll inspection for small gears</p>	
<p>ZWP 14/24</p>	<ul style="list-style-type: none"> - double flank gear roll inspection - robust - pneumatic slide possible 	

R

<p>ZWP 18</p>	<ul style="list-style-type: none"> - double flank gear roll inspection - highest precision 	
<p>ZWP 30</p>	<p>double flank gear roll inspection for large gear wheels, shafts and worms</p>	
<p>WSG</p>	<ul style="list-style-type: none"> - scanning gear inspection - comprehensive evaluation in shortest time - for larger series 	
<p>WSM</p>	<ul style="list-style-type: none"> - scanning gear inspection - comprehensive evaluation in shortest time - for larger series - adaptable 	

R

Universal Rotation Measuring Instruments with Measuring Ball URM-K

URM-K feature a high precision rotational axis and two linear axes. All three axes are manually operated in the manual version HM and evaluated using a PC. The automatic types work with three NC-controlled axes.

The URM-K instruments measure the diameters and the gear teeth. Probing of the gear flanks takes place whilst in double flank contact. The measuring balls are located on a turret, which is operated manually or automatically.

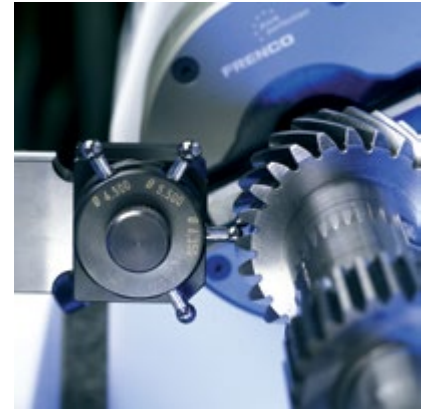

turret

Technical data		HGM	HGAL	HGAS	VA
part	max. length/height	750 mm	750 mm	750 mm	300 mm
	max. external \varnothing	230 mm	230 mm	230 mm	300 mm
	min. internal \varnothing	-	-	-	40
	min. pitch circle \varnothing	20 mm	20 mm	30 mm	40 mm
	max. weight	15 kg	15 kg	30 kg	20 kg
measurement range	slide	65 mm	85 mm	85 mm	150 mm
	horizontal/vertical slide	400 mm	750 mm	750 mm	300 mm
measurement sequence	manual	●			
	automatic		●	●	●
clamping	between tips manual	●	●		○
	between tips automatic			●	
	with triple jaw chuck	○	○		●
calibration	profiled setting master	●	●	●	●
	ground shafts	○	○	○	○
change of balls	manual	●	●	●	●
	automatic with turret		○	○	○

● standard

○ optional

URM-HGM-manual

Manual rotation measuring instruments have 3 axes which are operated manually.

They are particularly suitable for random inspections during production.



URM-HGAL-automatic

The three axes are NC-controlled. A measuring program coordinates the automatic measuring process.

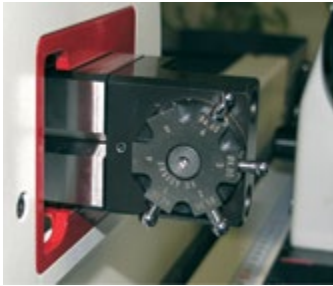

automatic turret



URM-HGAS-automatic

These devices feature three NC controlled axes and a tip center that can be programmed.

The tip center is pneumatically activated and can be integrated into the measurement process.



Software URMK



URM-VA-automatic

The vertical automatic URM instruments are delivered on a work bench, fully wired.

The vertical stroke is generated via ribbons equipped with a counterbalance for compensation.



R

Multiple Inspector RM

RM - horizontal

The typical place of use of URM-R/W inspection machines is directly next to the production machine. They can be used for quick random checks and are perfect for a 100 percent inspection.



Measurement of splines

Double flank gear roll inspection of two gears.

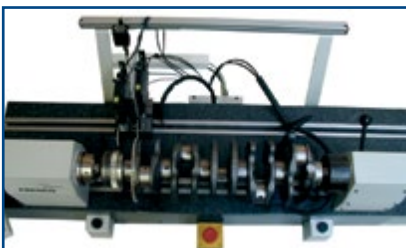

Measurement of a crankshaft

Measuring slide for splines.



Measurement of a shaft

5 measuring slides for 5 splines with index measurement. Prepared for automatic loading.



Technical data

		RM
part	max. length	750 mm
	max. external \varnothing	230 mm
	min. pitch circle \varnothing	20 mm
	max. weight	15 kg
measurement	slide	85 mm
measurement sequence	automatic	●
clamping	between tips automatic	●
calibration	profiled setting master	●
	ground shafts	○

● standard ○ optional

R



Special Designs

RM - vertical

Double flank gear rolling inspection with special evaluation for steering pinions.

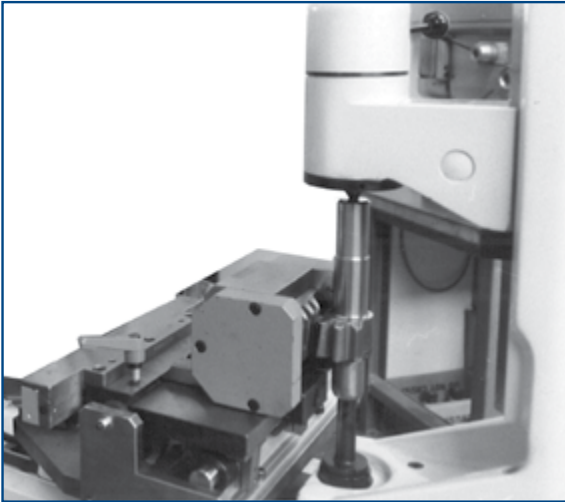

Double flank rolling inspection machine with a vertical slide and a tailstock.



R

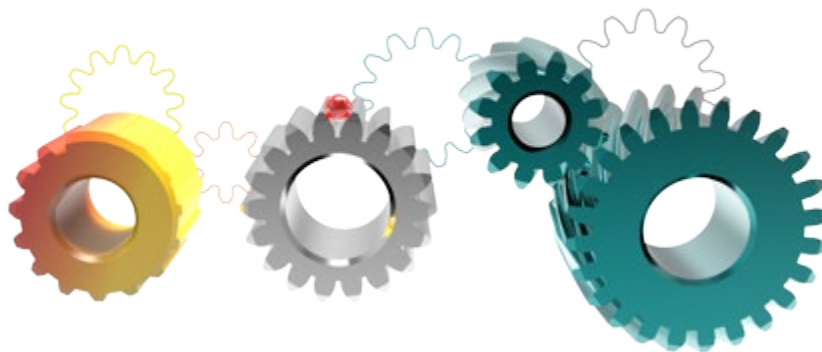

Software RMpro for Multiple Inspector

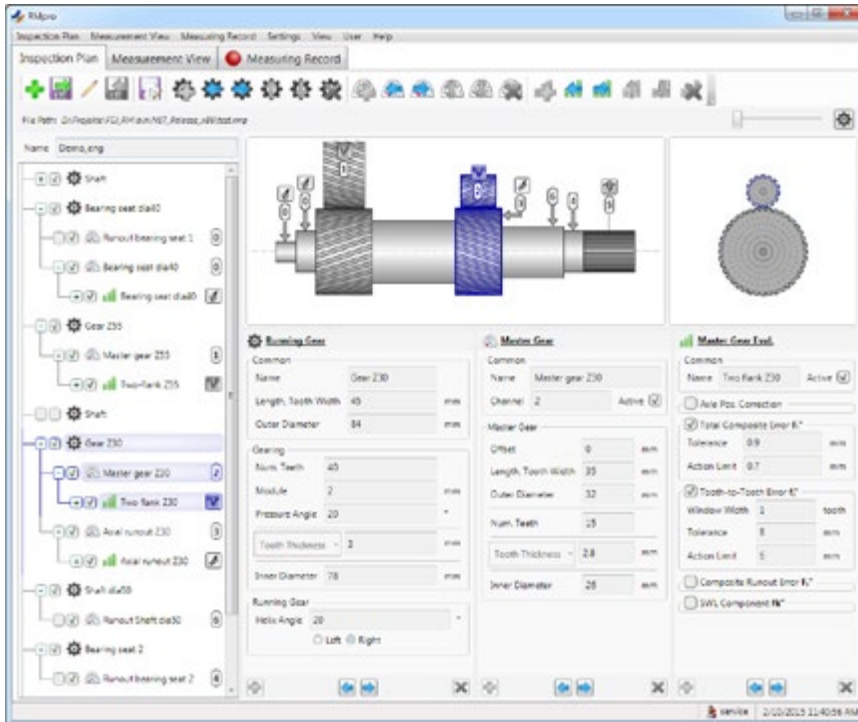

The RMpro software is used to measure and evaluate shafts with any number of measuring points. These measuring points can be: radial run-out, axial run-out, master gear or master wheel. The software provides a kind of modular system of components, measuring points, measurements, evaluations and representations.

The inspection plan is made up from the following lists: components, measurements, evaluations, representations and data exports. This ensures that measurements can be attached to components, and evaluations to measurements.

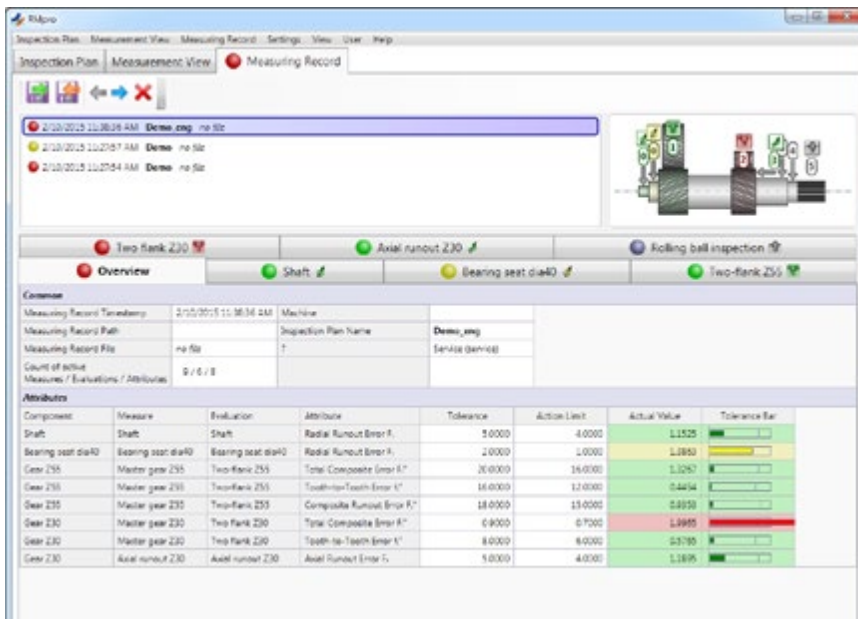

Axial position

Calculation of the axial position of the shaft can be carried out by linking the results of one to three measuring points. Individual measurements can then also be corrected using the established axial position.

Tolerance bar graph, evaluation graph, radial run-out diagram, axial run-out diagram, ZWP diagrams, master wheel diagram. An overview is available for the entire workpiece.





The measured values can also be viewed individually.

User Management

Integrated user management with user configurable group rights.

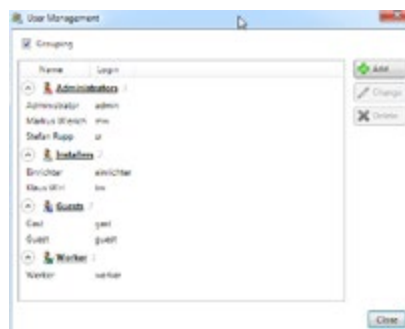
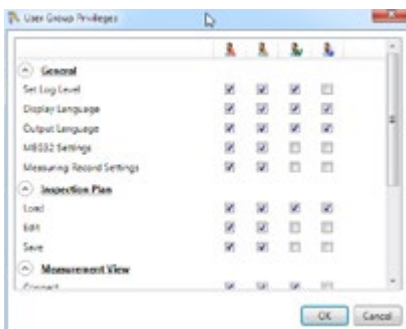

Data export

Export of the data in QS-Stat format.

System requirements

The software requires at least Windows 7 and the .NET Runtime Version 4.0.

RWL Rack

RWL inspection machines are suitable for quick and easy quality controls that are based on the double flank gear roll method.

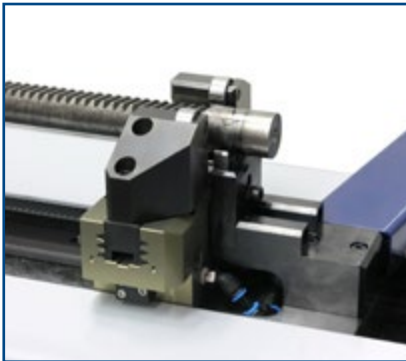

Horizontal slide

The workpiece is clamped pneumatically. The carriage is driven by an electric motor. The feed force is limited by a sliding clutch.



Measurement tower

The measurement tower is equipped with all necessary measuring systems. A measuring probe determines the tower's vertical stroke and an angular measurement system determines the configured pinion position.

Technical data

Technical data		RWL rack
part	max. length	1000 mm
	max. external \varnothing	40 mm
	min. external \varnothing	21 mm
measurement	slide	200 mm
measurement sequence	automatic	●
clamping	grab, proceeding	●
calibration	setting master	●

● standard ○ optional

R



Software for RWL Rack

“Rise and Fall” View

Displays the pitch curve F_i'' , plus nominal graph and tolerance area (green).

The short-wave components of the tooth-to-tooth radial composite deviation f_i'' are displayed separately.

Displays the coloured measurement results. Green: PASS, red: FAIL

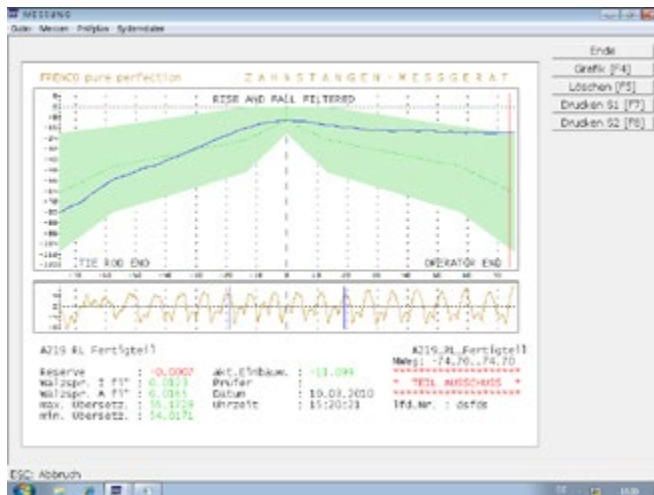

“Rack Gain” View

The rack gain is the calculated, covered track on the rack after one rotation of the master pinion gear.

The minimum and maximum values are displayed as min. and max. transmission ratio.

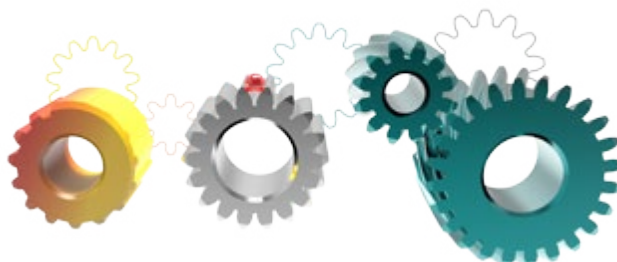
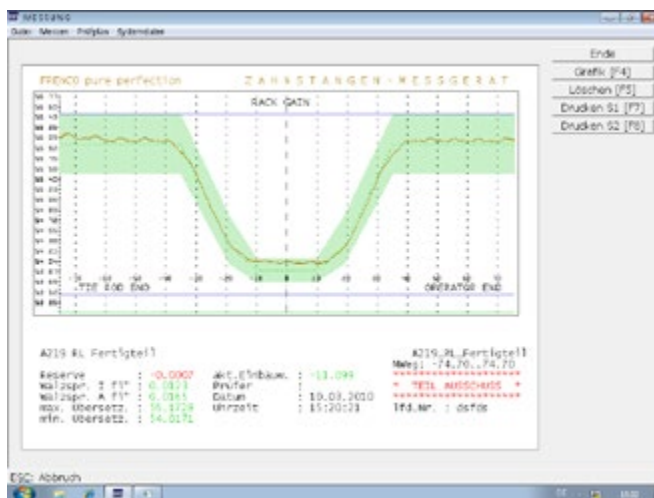

Double Flank Gear Roll Inspection Machines ZWP

The basic principle of the double flank gear roll inspection is that a master gear (nearly perfect gear) and a work-piece gear are meshing free from backlash. One axis of rotation is mounted firmly and the other is mounted in a floating manner. The variations in distance when rolling the two gears are detected and form the basis for the evaluation of the gear profile with respect to the existing composite error caused by production.

When used with modern evaluation solutions such as a PC, hardware and software, the double flank gear roll inspection proves to be an efficient means of controlling the quality in a quick and easy way.



Advantages of FRENCO's double flank gear roll inspection machines:

- Stable machines for the shop floor use.
- Customer-specific design: The machines are perfectly adjusted to the specimen to be measured and to the conditions of measurement.
- The measuring force is infinitely variable.
- Rapid lift-off of the measurement carriage.
- Using non-rotating tips and mounting mandrels, the runout deviation is kept low.
- Special master gear pair for calibration.
- With the evaluation software FGI pro being in-house developed, quick support is available should any issues arise.
- Elektronik MEG 32 of own development, produced in Germany. Quick support!
- The master gears are manufactured in-house at FRENCO in Altdorf, Germany.
- On request, we can upgrade older double flank gear roll inspection machines with FRENCO measurement electronics and the FGI evaluation software.

Measurement of Geometries:

- spur gears
- helical gears
- worms
- pinion and gear
- pinion and worm
- oil pump gear

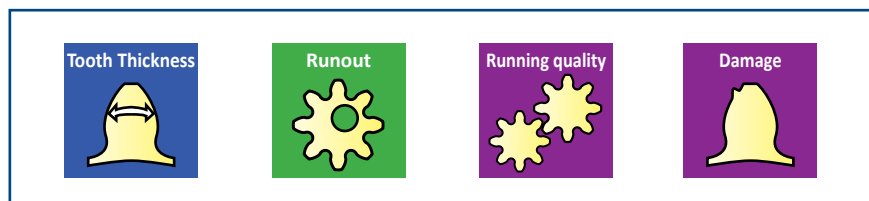

Double Flank Gear Roll Inspection Machines features:

	ZWP 06		ZWP 14/24*		ZWP 18		ZWP 30	
	single end	between tips	single end	between tips	single end	between tips	single end	between tips
Centre distance	12 – 85 mm	12 – 85 mm	45 – 170 (280)* mm	45 – 170 (430)* mm	45 – 175 mm	45 – 175 mm	120 – 550 mm	120 – 400 mm
Centre distance with adapter for small centre distances	1 mm	1 mm	15 mm	15 mm	15 mm	15 mm	-	-
Max. diameter of specimen with steady centre attachment 3	80 mm	80 mm	400 (430)* mm	160 (300)* mm	200 mm	160 mm 310 mm	-	450 mm
Max. diameter of specimen with extension adapter	-	-	-	-	300 mm	-	-	-
Centre height size 1		40–100 mm		60 – 220 mm		60 – 200 mm		up to 600 mm, higher on request
Centre height size 2	-		-	220 - 360 mm	-	220 - 360 mm	-	
Centre height size 3				0 - 420 mm		0 - 420 mm		
Range for height adjustable single end mounting	○		on request		100 mm		200 mm	
2nd steady centre attachment			○		○		○	
Adjustment of measuring force	0 – 5 N		possible within limits		0 – 20 N		0 – 50 N	
Glass scale	○				○		○	
Sensor for corrections of deviations of master gears	on request		○		on request		on request	
Range of application	small workpieces and plastic gears		large workpieces; robust for shop floor use		medium-sized workpieces; suitable for inspection laboratories		large wheels, worms and shafts, designed for heavy weights	
Motor drive	●		○		●		○	

*Version ZWP 24 is identical to ZWP 14, but has a larger machine base.

● standard ○ optional

ZWP 06

The universal measuring machine for small yet highly precise gears

The double flank gear roll inspection machine is specially designed for small high-precision gears. It is also suitable for plastic gears. The measuring force can be lowered to 0 N.

The sophisticated design is extraordinarily precise and sensitive. The measuring carriage is supported free from backlash on four leaf springs. This so-called parallelogram suspension is very sensitive and registers even the smallest change in centre distance.

The measurement process is motor driven by default. We recommend the FRENCO Software 'FGI pro' for the evaluation. This will enable you to control the quality of your workpieces easily, efficiently and reliably.



ZWP 06 with mounting device for internal gears and splines



ZWP 06 with centre fixture

An extensive range of accessories meets all requirements.



FRENCO



ZWP 14/24

Simple, robust, designed for shop-floor use

The ZWP 14 is the most robust double flank gear roll inspection machine of this product family and ideal for use on the shop-floor.

This machine can be driven manually or by motor. The centre distance can be adjusted manually via an adjustable adapter disc.

The measurement results are displayed on a dial indicator. An evaluation using our software FGI Pro is only possible if the machine is motorised.

The extensive range of accessories allows an individual customization to your requirements. Individual solutions for your measuring tasks are also possible.



ZWP 23P Modular design with pneumatic slide

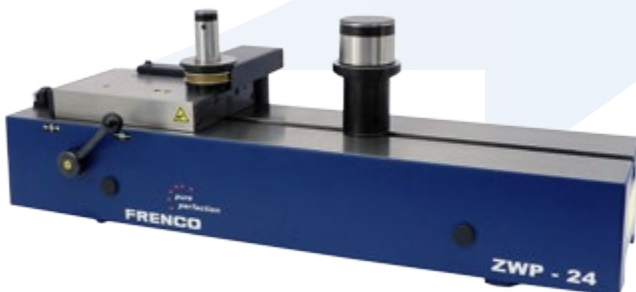

Special size ZWP 24

R

ZWP 18

Highest precision and comfortable handling

The high quality ZWP 18 features a sophisticated setup and allows high precision measurements.

The centre distance can be changed easily and quickly by adjusting the measuring carriage with a hand-wheel. The adjustable mandrel allows simple and convenient adjustment of the height of the gears to be inspected. Many accessory items can easily be attached to the instrument.

The drive is integrated into the device. To ensure highest precision, the measuring carriages are mounted on very smooth guideways.



ZWP 18 with steady centre attachment



ZWP 18 with worm gear attachment

R

ZWP 30

The specialist for large gear wheels, shafts and worms

With ZWP 30 it is possible to measure gears and splines with a pitch circle diameter of up to 550 mm and shafts with a length of up to 600 mm.

The design is stable and optimized for the shop-floor use. The workpieces' large dimensions and heavy weight require special components to be installed.

A granite machine bed forms the base of the ZWP 30 onto which the measurement carriage and mounting attachments for the workpiece and master gear are installed. Despite heavy weight loads, it is important for the measurement carriage to move smoothly, precisely and free from backlash, which is ensured by the cross roller guides.

The changeover for the inspection of other specimens is easily and quickly to handle. Depending on the customer's requirement, the measurements are carried out manually or automatically. The evaluation is carried out via a dial indicator or FRENCO's FGI pro software.



R

Software „FGI pro“ for Double Flank Gear Roll Inspection Machines

The software FGI pro includes both, the control of the drive and the evaluation of data. The software is in-house developed and programmed by our specialists for applications software. With the actual values being marked in colour, the specimen can quickly be evaluated as 'Pass' (green) or 'Fail' (red).

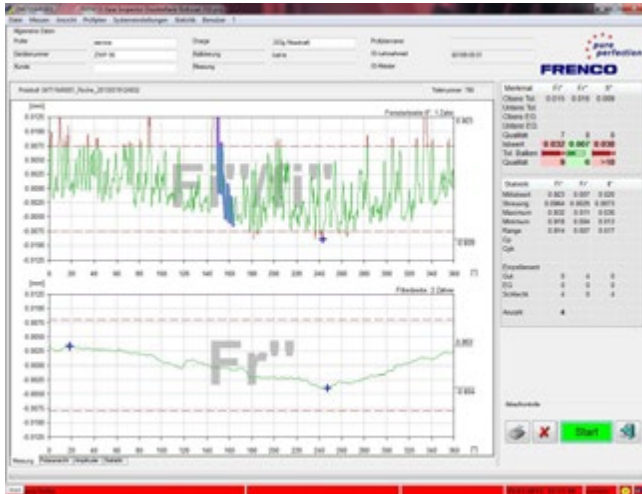

The software determines the following values:

- total radial composite deviation F_i''
- tooth-to-tooth radial composite deviation f_i''
- runout deviation by composite test F_r''
- short-wave component f_k''

Additionally, when machine has been calibrated:

- centre distance A_a''
- dimension over balls M_dk
- tooth thickness S_n
- span size W_k

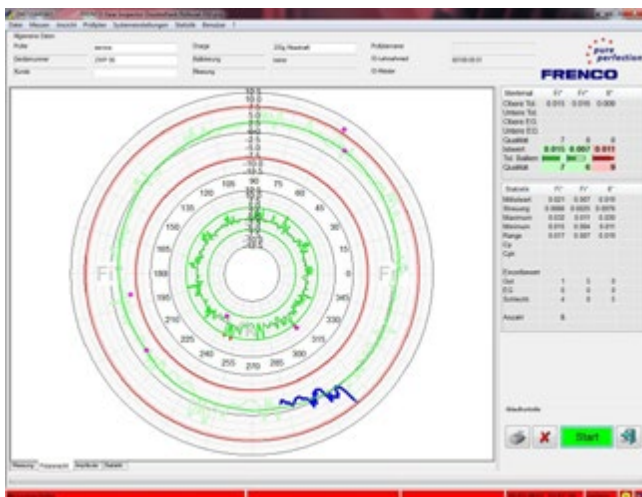

Polar chart

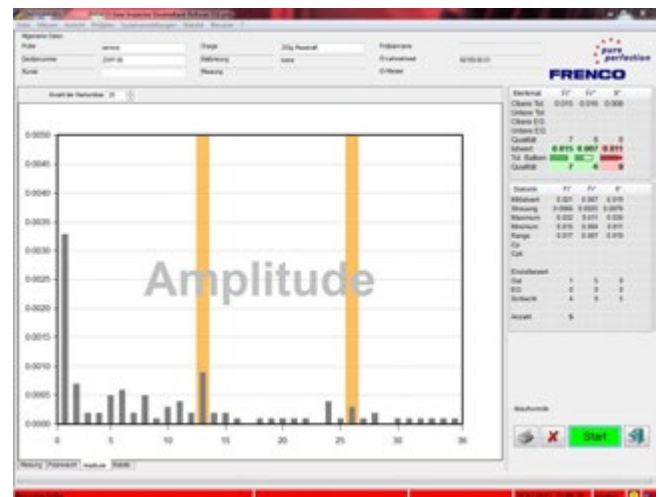

Visualized Fourier spectrum

Further software properties:

- Easy input and amending of inspection options
- After the inspection, the workpiece will be turned to the position of maximum deviation (values are selectable)
- Language features:
 - German, English, Spanish, French, Portuguese, Polish, Hungarian and Chinese are available
 - Program language and output language can be selected separately (Unicode support)
 - Easy data exchange when corporate languages are different
- Archiving function: every single measurement data is saved
- Central, statistical analysis due to interfaces (qs-STAT[®], CASQ-it 9000 and internal Ethernet-systems)



Retrofit

FRENCO retrofits earlier double flank gear roll inspection testers with the powerful measuring electronics MEG 32 and the evaluation software FGI pro. The upgrade is ideal for devices with manual evaluation, pen recorder or earlier electronics.

For retrofitting, please send the machine to FRENCO GmbH. The device will be dismantled, cleaned and smaller repairs will be carried out. Furthermore, probe and motor will be replaced and an emergency-stop button will be installed (unless one is already installed).

The double flank gear roll tester will be completely refurbished!

The following devices can be retrofitted:

- Mahr 894B, 896B, 898B, 898C
- Hommel ZWG8305, ZWG8315
- Höfler ZW300
- other types on request



Hommel ZWG 8305 after retrofitting



Höfler ZW300 before retrofitting



Höfler ZW300 after retrofitting

R

pure perfection

FRENCO

Gear Flank Analyser

The method of gear flank analysing is based on the single flank gear test. A specially designed roll master ensures a contact ratio of less than one. Thus the gears briefly lose contact in-between two adjacent teeth. As a result, the specimens' deviations can be assigned precisely to the tooth number. The actual measurement takes place during the rolling process. The driving path is only a means of transportation and is irrelevant for the measurement.

Furthermore, the roll master is designed to measure the specimen in more than 13 independent planes. In short:

Gear flank analysing conducts an individual error test of all teeth in several planes.

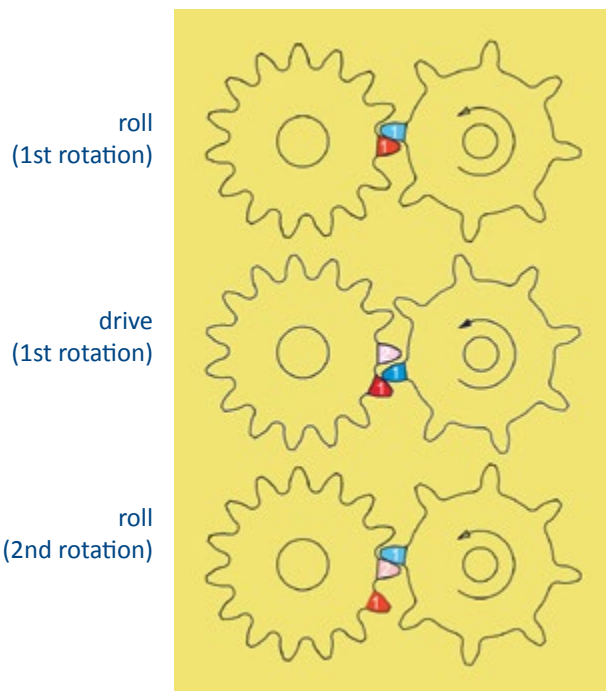
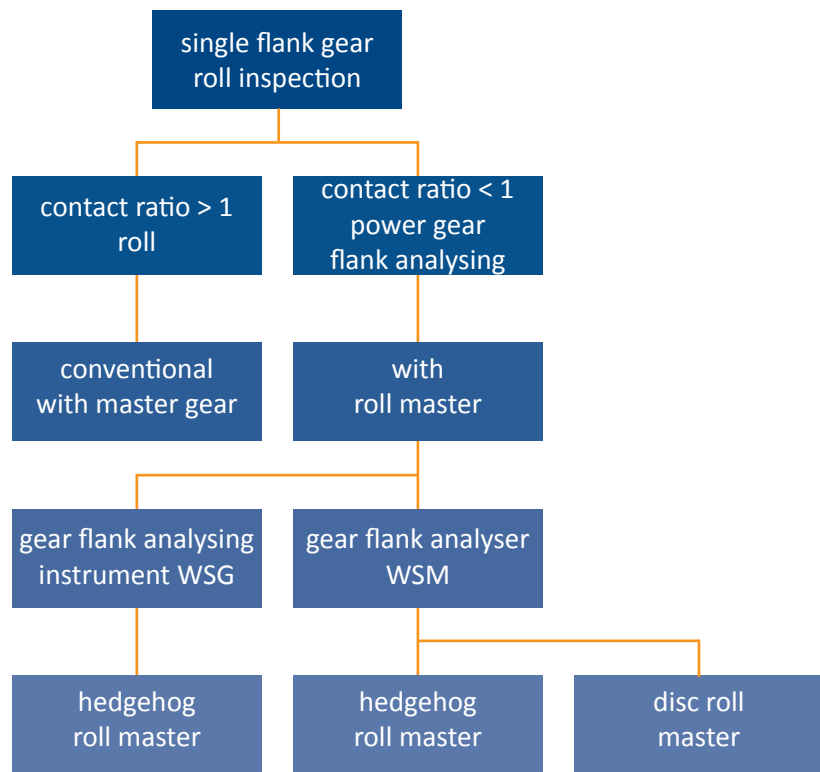

Measurement with contact ratio less than 1

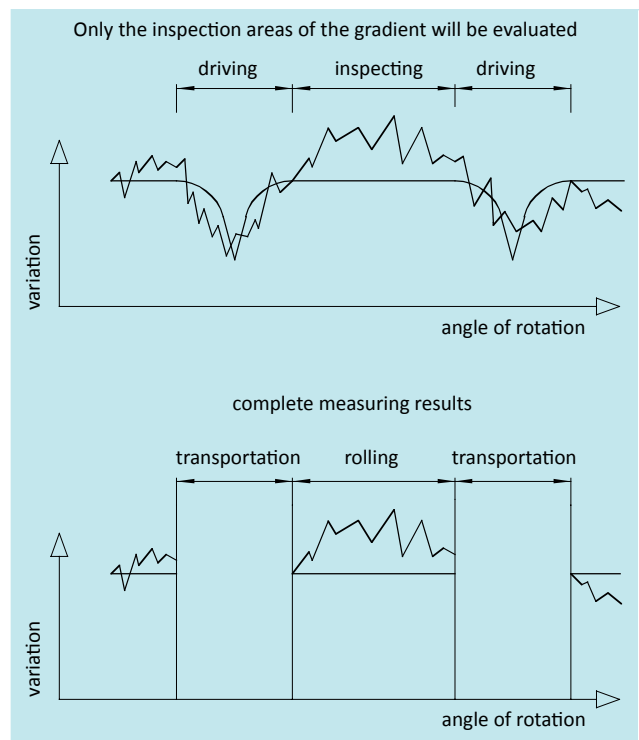

R



Measuring tasks:

Depending on the number of teeth and the device, the entire gear profile can be scanned within 3 to 13 minutes. It is possible to evaluate a large number of other parameters, besides the usual parameters, such as profile, pitch and runout, with the measuring time remaining the same.

Gear flank analysing measuring allows an extensive and still efficient quality evaluation.

The machines are designed for use in production and may replace the inspection in a measuring room. Whenever there is an error, the reaction time is extremely short. The gear flank analysing machines only render their full contribution when high volumes and consistent gear geometries are measured.

The number of measurement amounts to 60-100 per day and machine.

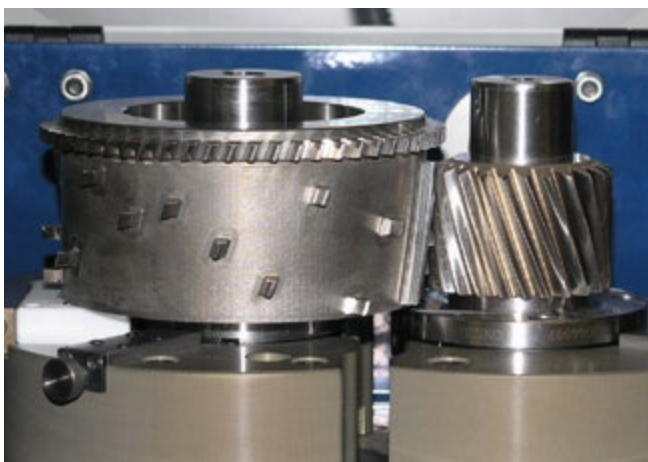
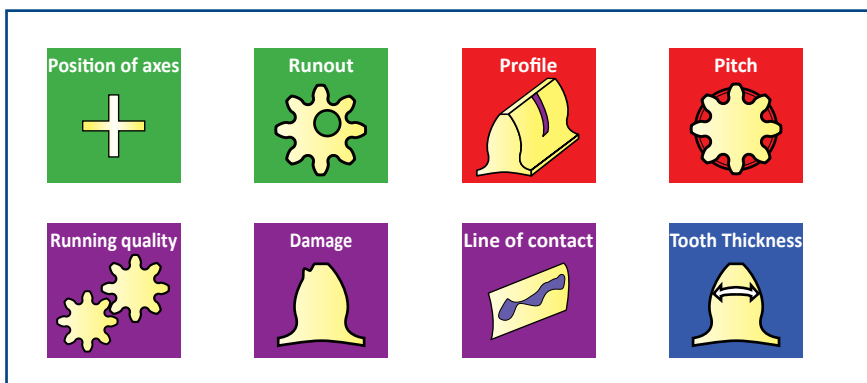

Gear flank analysing with master



Gear flank analysing with disc roll master

R

Gear Flank Analyser WSG

Gear flank analysing machines WSG use hedgehog roll masters. These are master gears with tooth segments that are adapted to the gear geometry to be measured.

Due to the segments vertical offset it is possible to evaluate the workpiece geometry in several planes.

This ensures that the profiles of all tooth flanks are detected in several planes, which enables a calculation of the tooth traces.

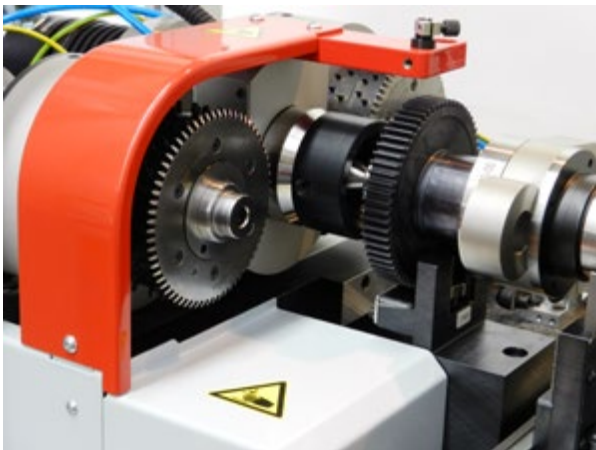
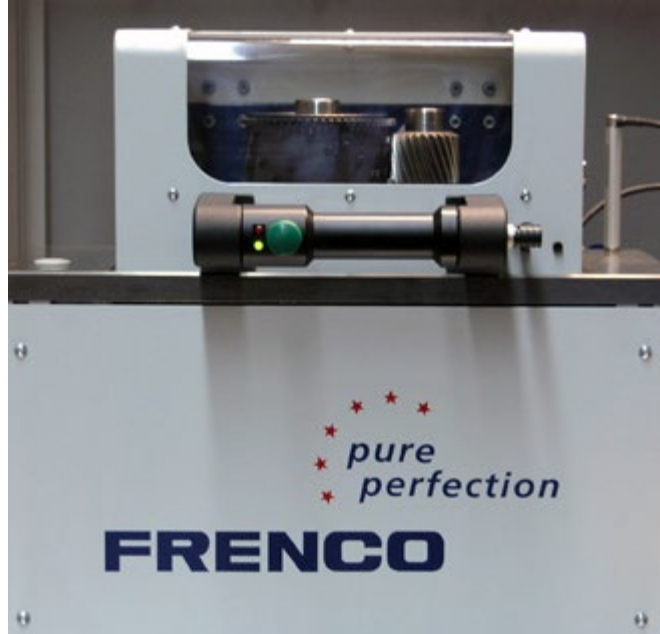

Gear flank analyser with double spindle:
cuts measuring time by half



Hedgehog roll master

R

Gear Flank Analyser WSM

Gear flank analysing is based on the principle of the single flank gear roll inspection and the roll master is adjusted to the gear profile to be inspected. Two rotations of the master complete the inspection of the set plane of the workpiece. Rotary axis A of the workpiece and rotary axis B of the roll master are electrically connected. Simultaneous movement of axis Z1 and axis Z2 enables measurements in as many planes as necessary.

The tip centre distance and the position of the gear profile to be inspected are logged in the inspection plan and automatically controlled during the process.

The x axis controls the centre distance and is positioned automatically.

Depending on the workpiece, the measurement in 10 planes takes about 4 minutes.



disc gear flank analysing master

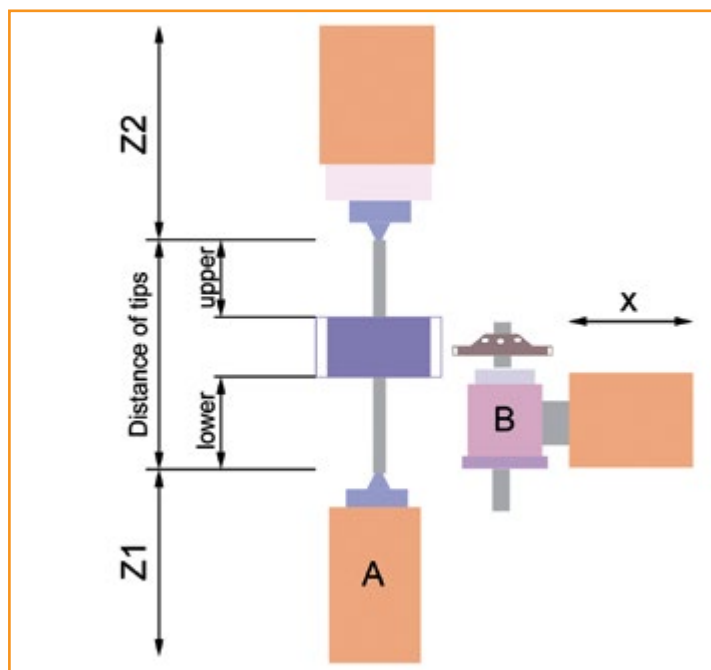

- A = axis of rotation of the workpiece
- B = axis of rotation of the disc scanning master
- Z1 = upper centre position
- Z2 = lower centre position
- X = centre distance

R



Methods of Evaluation

The latest version of the evaluation software supports various graphic charts and evaluations- including unique and basically new assessments for the completely detected tooth flanks.

Standard evaluation of profile, helix (of four teeth), pitch and runout plus profile and helix of all teeth, detecting the worst tooth. All important values are clearly displayed in various charts.

Production



Quality control charts can be selected separately for all attributes depending on the processing machine. An overview of all evaluations is given.



Evaluation

Topographical evaluation of the measurement results, Fast Fourier Transform (FFT) analysis for roll distance and acceleration (per measurement and FFT history) and calculated measurement results of a single flank gear rolling inspection are displayed.

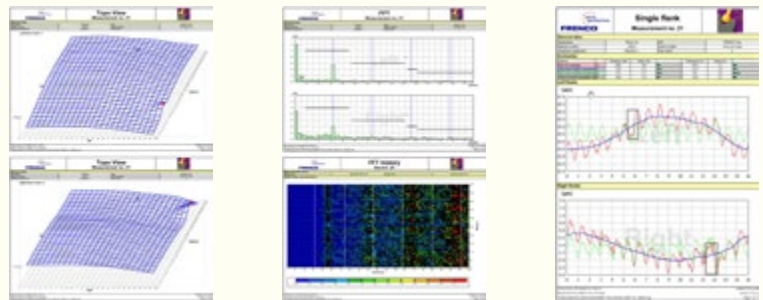

Function

Illustration of the tooth position

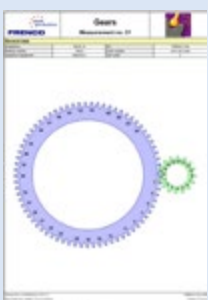

Localisation

REANY analysis of the measurement results represented by various charts and illustrations e.g. Reany Overview, position of axis and pitch. The software includes a correction of the axis.

Reany

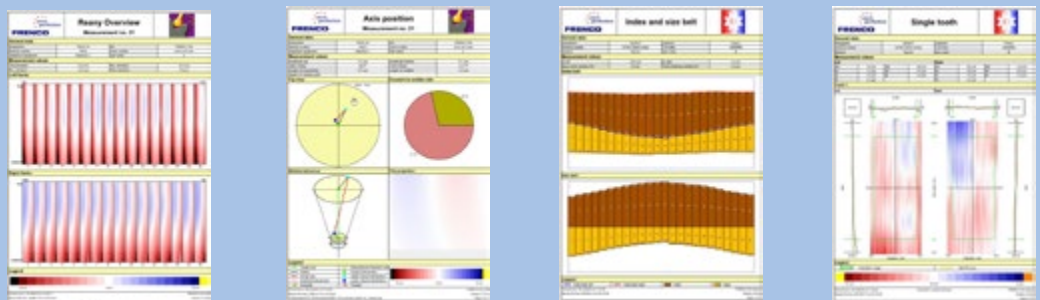

This evaluation is available for both, gear flank analyser and all-teeth measurement on coordinate measuring machines.





R

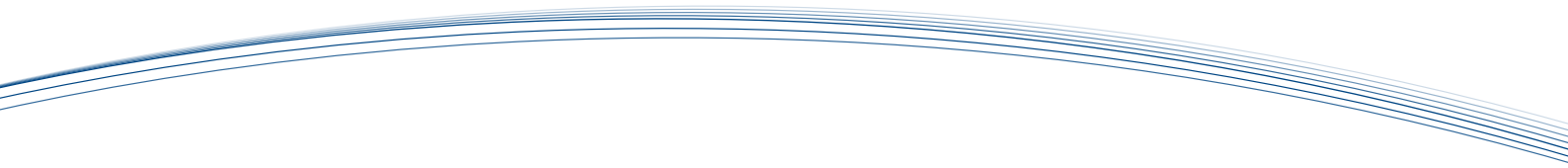

pure
perfection

Gear and Spline Inspection to Accredited Standards

Monitoring of Inspection Equipment
Workpiece Inspections
Online Inspection Certificate
DAkkS-Calibration
VDA-5-Certificate
Analysis of Deviations



P

Inspection services

pure
perfection



Deutsche Akkreditierungsstelle GmbH

Entrusted according to Section 8 subsection 1 AkkStelleG in connection with Section 1 subsection 1 AkkStelleGBV
Signatory to the Multilateral Agreements of EA, ILAC and IAF for Mutual Recognition

Accreditation



The Deutsche Akkreditierungsstelle GmbH attests that the calibration laboratory

Frenco GmbH, Verzahnungstechnik, Messtechnik
Jakob-Baier-Straße 3, 90518 Altdorf

is competent under the terms of DIN EN ISO/IEC 17025:2005 to carry out calibrations in the following fields:

Dimensional Quantities
Length
- Gear Quantities

The accreditation certificate shall only apply in connection with the notice of accreditation of 07.03.2012 with the accreditation number D-K-15199-01 and is valid until 06.03.2017. It comprises the cover sheet, the reverse side of the cover sheet and the following annex with a total of 4 pages.

Registration number of the certificate: **D-K-15199-01-00**

Braunschweig, 07.03.2012

Dr. Michael Wolf
Head of Division

This document is a translation. The definitive version is the original German accreditation certificate.
See notes overleaf.



Deutsche Akkreditierungsstelle GmbH

Anlage zur Akkreditierungsurkunde D-K-15199-01-00
nach DIN EN ISO/IEC 17025:2005

Gültigkeitsdauer: 07.03.2012 bis 06.03.2017

Urkundeninhaber:

Frenco GmbH, Verzahnungstechnik, Messtechnik
Jakob-Baier-Straße 3, 90518 Altdorf

Leiter: Dipl.-Ing. (FH) Ino Kühn
Stellvertreter: Dipl.-Ing. (FH) Thomas Peter
Jürgen Stelzweg

Akkreditiert als Kalibrierlabor seit: 17.04.2000

Kalibrierungen in dem Bereich:

Dimensionelle Messgrößen
Länge
- Verzahnung

P

pure
perfection

General Information

FRENCO is the first address for gear and spline inspection in Germany. Our equipment enables us to measure nearly all types of gears and splines. A constant room temperature, best quality equipment and top qualified employees guarantee highest precision. The traceability to PTB (the national metrology institute of Germany) verified artefacts - from measuring pins to profile, tooth trace and pitch artefacts - ensure reliable measurement results.

FRENCO's calibration laboratory is awarded accredited conformity assessment body status by DAkkS in accordance with EN ISO/IEC 17025 (registration number D-K-15199-01-00). FRENCO is therefore entitled to calibrate cylindrical gears (all features) and issue a DAkkS calibration certificate. You will receive the most accurate DAkkS calibration throughout Germany.

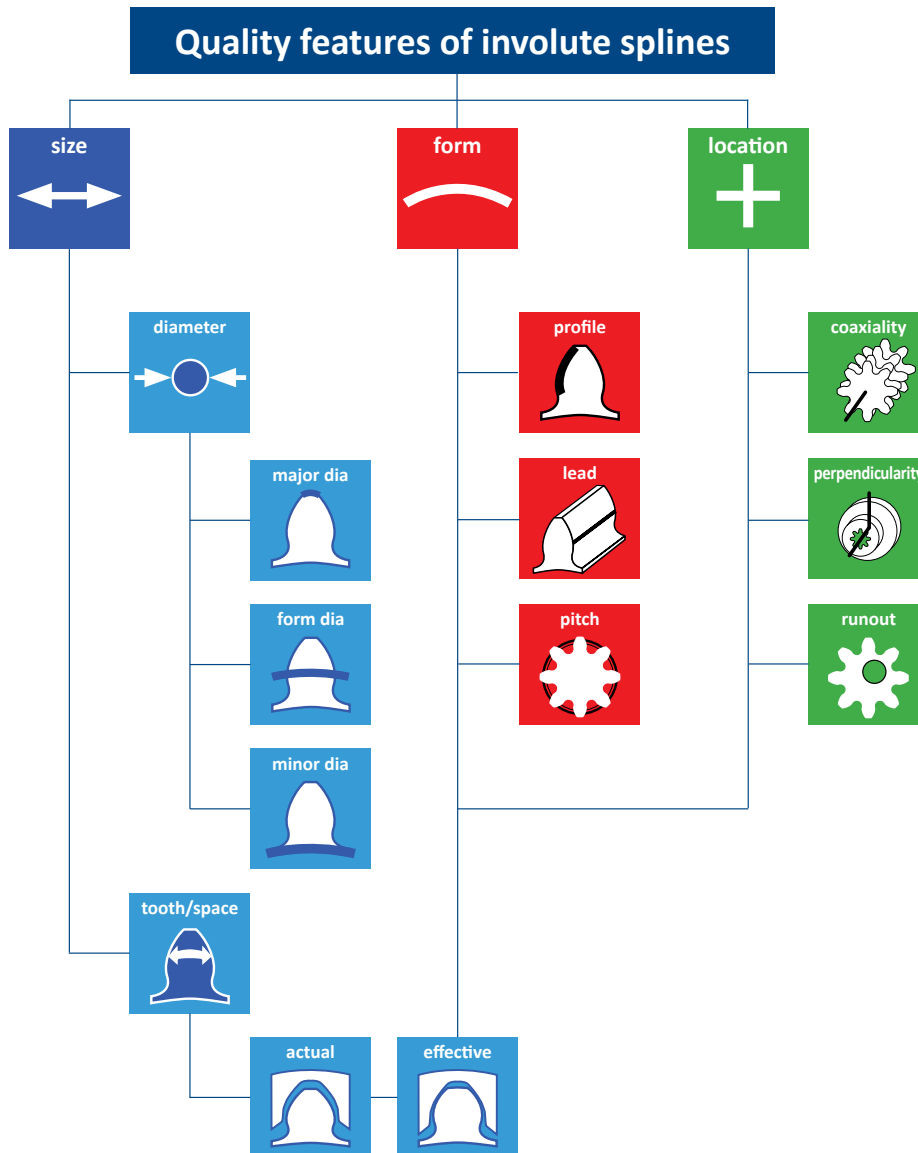

P



Monitoring of Inspection Equipment

Scope of services

All measuring and inspection equipment for external and internal gearing, such as gauges, master gears, taper mounting mandrels, instruments for size inspection and others are inspected. Standard monitoring of inspection equipment conforms to the directive VDI 2618 sheet 1 and includes the following services:

- Verification of the number of items delivered
- Cleaning
- Demagnetisation
- Visual inspection for damage
- Determination of the gear and spline data by means of an existing drawing, or
- Determination of the gear and spline data by means of standards, or
- Creation of an inspection equipment drawing (additional charge)
- Removal of smaller damage on the gearing, whenever possible
- Size inspection of the gearing by hand with Abbe length measuring device or the length comparator
- Form inspection such as profile, tooth trace, pitch and radial runout on our measuring machines
- Issuing of an inspection certificate in German or English
- Electronic archiving of the measurement results at FRENCO
- Providing the measurement results online at www.frenco.de
- Re-marking (additional charge)
- Verification of workpiece design (on request)
- Packing in a rust protective foil

Note: If the measurement is terminated early due to detection of a feature outside the tolerance, the price will be reduced according to actual time and effort in the calibration laboratory.

Delivery time

Delivery is approx. 2 weeks from receipt of the inspection equipment or measurement items (in Altdorf). The delivery time can be reduced to 3 working days (surcharge). Delivery for DAkkS calibrations is approx. 10 weeks from receipt (in Altdorf). Shorter delivery times are also possible on request.

Documentation

An inspection certificate is issued for each inspection object. This includes:

- Inspection equipment data, nominal sizes, actual sizes and the overall evaluation on the first page.
- Depending on the delivery volume and type of instrument, the graph of the gear inspection centre including profile and tooth trace, pitch and radial runout on the inside pages.
- Explanation abbreviations, traceability and measurement uncertainties on the last page.

Delivery

We kindly ask you to send the measuring instruments to us free of charge and to ensure that the goods are packed accordingly in order to avoid damage. Goods will be returned ex works via parcel service. Please inform us, if required, of preferred carrier.

P

Workpiece Inspection

Workpieces gearing can be inspected in a number of ways:

- Individual form inspection on gear measuring machines (profile, tooth trace, pitch and radial runout)
- Double flank gear test on a FRENCO gear tester. A master gear and clamping equipment is required.

Individual form inspection can be carried out on external and internal gears as well as involute, serration and straight-sided splines. We can inspect the following workpieces:

- Max. diameter of workpiece: 400 mm (worm gears 260 mm)
- Max. length of workpiece: 650 mm
- Max. vertical measuring range: 500 mm
- Min. module: 0.1 mm (0.3 mm internal gears)

Additional possible measurements:

- Position of functional faces (circles, cylinders, plan faces etc.) in reference to the gear/spline axis
- Topography of individual teeth or 'All-tooth-measurement')
- Roughness and contour measurements

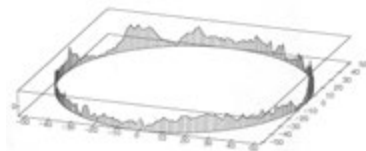
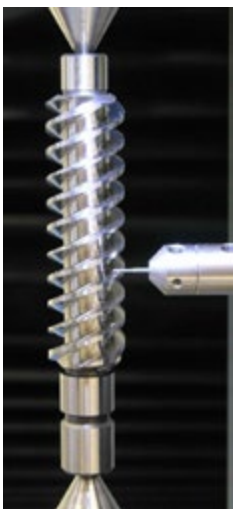
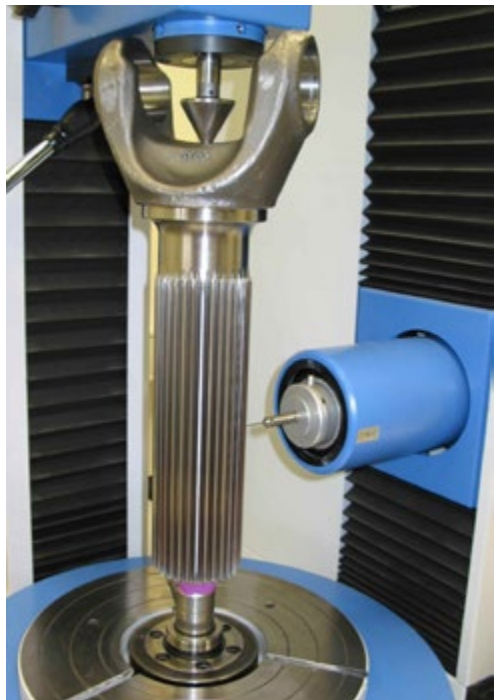
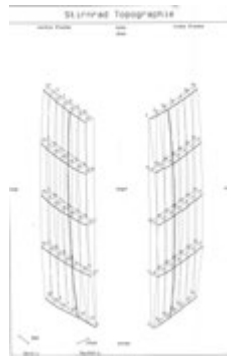

P

Online Inspection Certificate

The screenshot shows the FRENCO website interface. At the top, there is a navigation bar with links for Home, Sitemap, T&C, Contact us, Legal notice, and a search bar. Below this is a secondary navigation bar with links for About Frenco, Product Groups, Downloads, News/Events, and DAKS. The main content area is titled 'Downloads' and features a large green arrow pointing down next to the FRENCO logo. To the right, the company address is listed: FRENCO GmbH, Jakob-Bauer-Strasse 3, 90518 Alford, Germany. A sidebar on the left contains a menu with options: Demo software, FGI pro, Inspection certificates (highlighted), Remote Support, Brochures, and Customs information. The main content area displays the 'Inspection certificate' download option, with a preview of the certificate. The certificate is titled 'Certificate new condition' and contains a table with technical data. The order number '20132725' and record ID '162207' are circled in red in the preview. Below the table, there is a form for entering the order number, with '20132725' entered.

name	sign	date	customer
Technician	?	06.08.2014	Customer X
order number	record id	drawing number	
20132725	162207	4711 00 11 08	
customer part no.	serial part no.		
4711 001.054 1nd 11	08-01		
part name			
Mastergear m1,2 - α20° - z41 - 018°4423°R - B - DND970 - Sn = L8844			
*) the adding on the master gear corresponds to the new condition.		size and tolerance [mm]	actual size [mm]
major diameter		54.000 -0.030	53.975

The inspection certificates for inspection equipment and workpieces calibrated by FRENCO, can be downloaded in PDF format from our website. A detailed description can be found on www.frenco.de.

Note:

Before destroying the paper certificate, please save the record ID and order number. Without these the online certificate cannot be retrieved.

P

DAkks Calibration of Artefacts...

FRENCO's calibration laboratory is awarded accredited conformity assessment body status by DAkks in accordance with EN ISO/IEC 17025 (registration number D-K-15199-01-00) for all essential gear features.

Tooth trace artefacts and involute artefacts as well as pitch artefacts and artefacts for pitch, radial runout and dimension over measuring circle can be DAkks calibrated.

The accreditation is valid for the most commonly required measuring ranges. Details of the accreditation range can be found on www.dakks.de.

Artefacts which are outside this accreditation range can be factory calibrated.

The customer will receive a (DAkks) calibration certificate (multiple pages) with explanations regarding the measuring method, information on the location determination of the measured item and of course with specification of the measurement uncertainties.

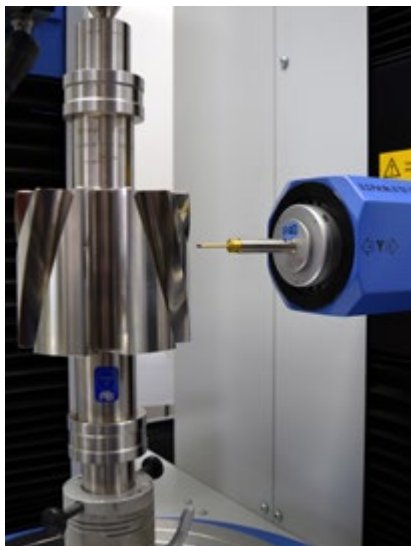

Traceability

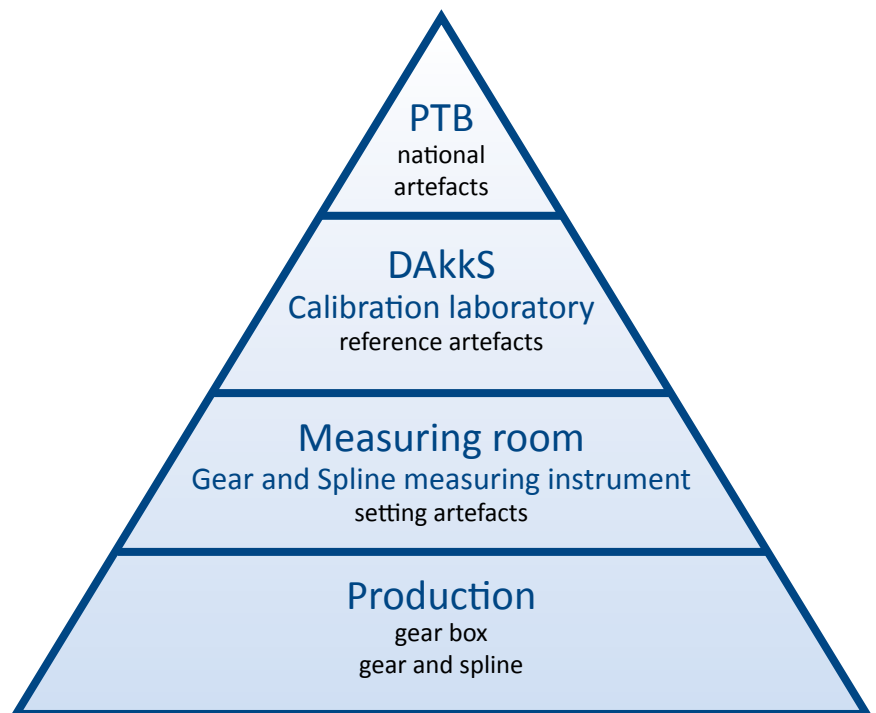

... and IC-Artefacts

The smallest measuring uncertainty to be specified depends on the size of the artefact. Measuring uncertainty of DAkkS calibrations lies within the following range:

	U (k=2)	U (k=2)	U (k=2)
Profile	F_{α} : 1.5 - 2.1 μm	$f_{H\alpha}$: 1.1 - 1.9 μm	$f_{r\alpha}$: 0.9 - 1.0 μm
Tooth trace	F_{β} : 1.5 - 2.0 μm	$f_{H\beta}$: 1.1 - 1.8 μm	$f_{f\beta}$: 0.9 - 1.0 μm
Pitch/ radial runout	F_p : 0.7 μm	f_p : 0.6 μm	F_r : 1.0 μm
Size over measuring circles	M_{dk} : 1.2 μm		

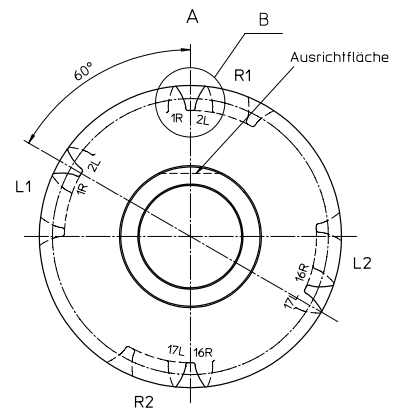
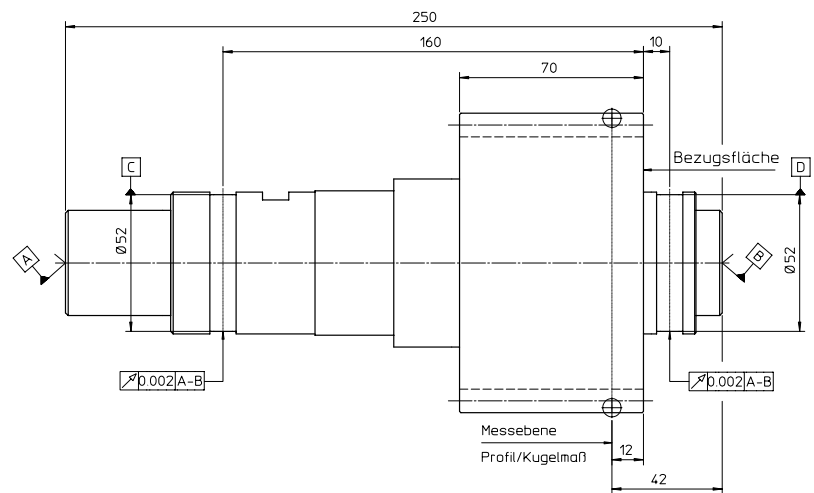

VDA-5 – Certificate for Measuring Instruments

On request FRENCO issues a VDA-5 certificate for all measuring instruments. This certificate is designed according to VDA 5 and contains the measuring uncertainty of the measuring system. It enables an easier determination of the measuring uncertainty of the inspection process in accordance with VDA 5, as the measuring uncertainty of the inspection instrument only has to be inserted. Moreover, parameters such as Q_{MS} , $TOL_{MIN-UMS}$, C_{gk} and C_g - which are also indicators for the gauge capability of an instrument- are listed on the certificate.

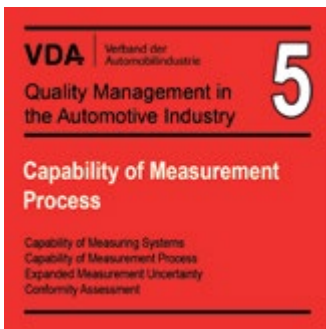

Uncertainty of the measuring system UMS according to VDA 5

FRENCO GmbH Jakob-Baier-Strasse 3 90518 Altdorf Tel.: +49 9187 9522-0 Fax: -40 www.frenco.de

FRENCO		VDA-5 Certificate		27.09.2013	
acc. to VDA 5 (2. Edition Update 2011)		Proof of Measurement System Capability		Inspector: Frenco Prüfer	
Drawing No.: 61046 10 00 00	Part No.: 01	Type: IVMF 1x1	U= 23.4025	L= 23.3483	TOL= 0,054
%RE Resolution of indicator u_{RE}			Resolution: 0,001 (=half scale division)		
Resolution RE in %:			1,8% I.O. => no ure		
if Resolution RE > 5% then calculate u_{RE}			$u_{RE} = 0,00 \mu m$		
Calibration uncertainty u_{CAL}			Measuring uncertainty of setting-master (ref. certificate):		
Drawing No.: 61046 11 03 00 Teil 01			$u_{CAL} = 2 \mu m$		
Repeatability on reference standard u_{EVR}			25 repeat measurements on setting ring including probe [μm]:		
1...5	0,0	0,0	-0,1	-0,2	-0,2
6...10	-0,1	-0,1	0,0	0,0	0,0
11...15	0,0	0,0	0,0	0,1	0,1
16...20	0,2	0,3	0,1	0,0	0,1
21...25	-0,1	-0,2	0,1	0,2	0,3
Resolution of Probe: 0,0001			$s_g = 0,138$		
Proportion: Resolution / $s_g > 2$?			yes, it follows $uw=sg$ 0,03		
			$u_{EVR} = 0,14 \mu m$		
Uncertainty from linearity and bias u_{BI}			Normal		
	Actual value x_m in mm	Measurement x_g [mm]	Deviation [μm]		
x_{m1}	23,4025	23,4028	0,3		
x_{m2}	23,4025	23,4031	0,6		
x_{m3}	23,4025	23,4031	0,6		
x_{m4}	23,4025	23,4030	0,5		
x_{m1}	23,3754	23,3750	-0,4		
x_{m2}	23,3754	23,3753	-0,1		
x_{m3}	23,3754	23,3755	0,1		
x_{m4}	23,3754	23,3754	0,0		
x_{m1}	23,3483	23,3480	-0,3		
x_{m2}	23,3483	23,3478	-0,5		
x_{m3}	23,3483	23,3479	-0,4		
x_{m4}	23,3483	23,3478	-0,5		
			$u_{BI} = 0,29 \mu m$		
Uncertainty form dial indicator u_{MS_REST}			Dial indicator missing - set to "0": 0 μm		
factor 0.58			$u_{MS_REST} = 0,00 \mu m$		
Expanded uncertainty U_{MS}			$U_{MS} = 2,10 \mu m$		
Capability ratio Q_{MS}			$Q_{MS} = 8\%$		
$Q_{MS} \leq Q_{MS_max}$?			MS capable		
Minimum possible tolerance $TOL_{MIN-UMS}$			$TOL_{MIN-UMS} = 0,021 mm$		

U_{RE}

U_{CAL}

U_{EVR}

U_{BI}

U_{REST}



Resulting from 25 repeat measurements (incl. C_g und C_{gk})



P



Deviation Analysis

The measuring results from gear measurements taken on-site are digitally filed and can be used in a gear and spline analysis program.

This program can be used to:

- change the position of axis,
- overlay multiple measuring results for comparisons,
- select representations depending on the tooth thickness,
- correct machine settings (profile grinding),
- detect disturbances in the production process,
- simulate changes of the gear and spline data,
- generate new gear and spline data.

This analysis program helps to understand correlations, find reasons for and detect sources of faults. Moreover, it features the ability to change parameters quickly and interactively. The most important feature is, however, that the data output will be given in a way familiar to the user, as a measuring result.

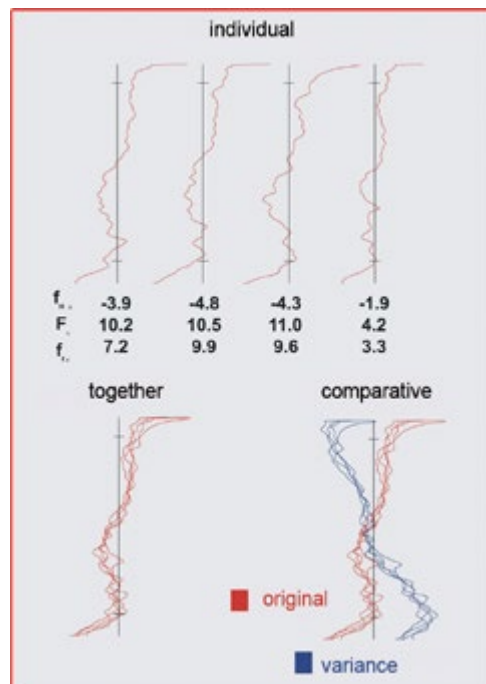
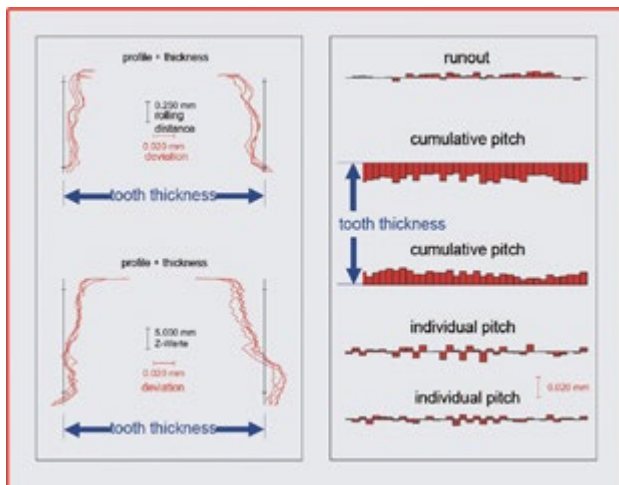
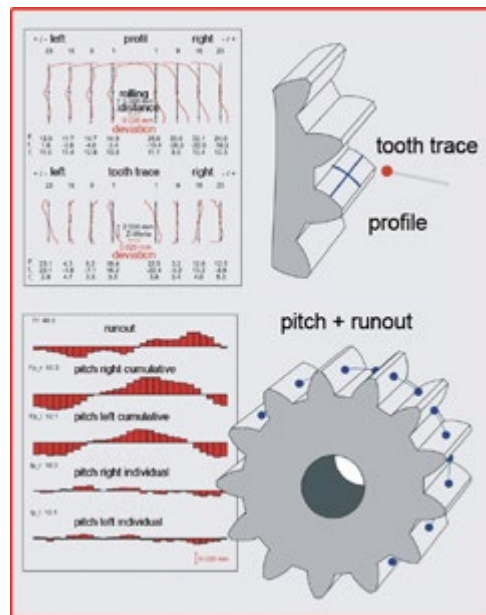

P

'All-Tooth-Measurement' with REANY Evaluation

What is an ,all-tooth-measurement'?

An 'all-tooth-measurement' is defined here at FRENCO's as the capture of several profiles and tooth traces of all teeth. This means nearly the entire gear or spline is measured. The relation between the flanks is maintained, which is the main difference to topography, where individual teeth without any reference to each other are included.

What is a REANY evaluation?

REANY is short for reality analysis. It is a novel evaluation method of topological deviations of the tooth flanks. This methods allows, for example, an evaluation of dimensional deviations and pitch deviations along the entire face width. It is also possible to determine the positional deviation of the wheel axis, to eliminate deviations via the software and to receive an unprecedented wealth of information with just one single measurement.

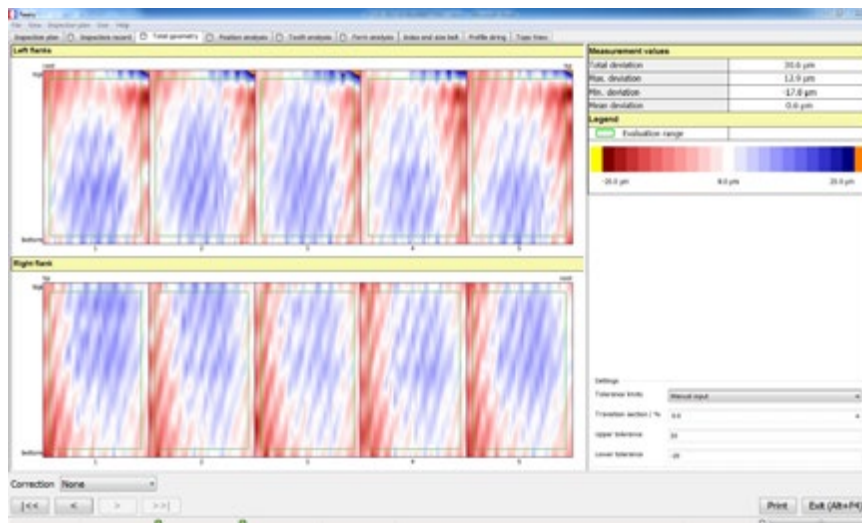

Topological deviations of all tooth flanks

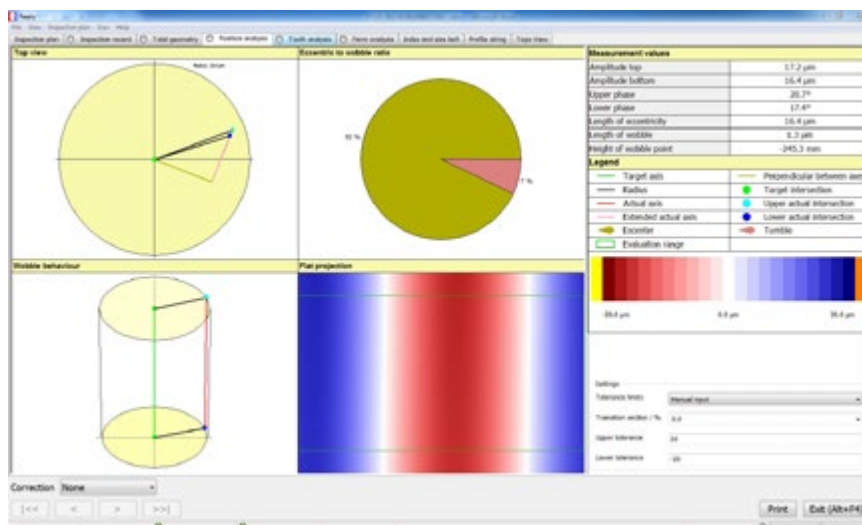

Eccentric or wobble? How big is the influence of the positional deviation? REANY will let you know

Common Measurement

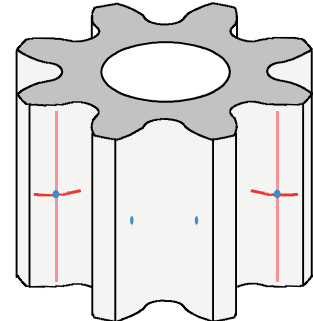

measured profiles,
tooth trace
and pitch

Measurement of all teeth

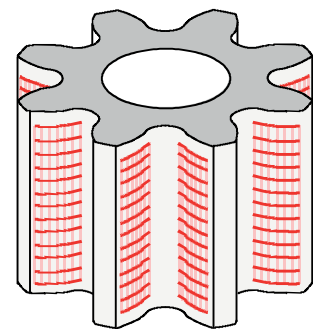

measured profiles
tooth trace

The long measuring time is worth every second!

A total error inspection, like a double flank gear rolling inspection, is often carried out in production environments. If parts are rejected a cause must quickly and precisely be identified. The usual sampling inspection soon reaches its limits and additional measurements are required. The long measuring time is worth every second, thanks to REANY. You will learn everything about the inspected item with brand new representations and possibilities.

Comprehensive and individual consultation is included when planning an order with FRENCO.





P

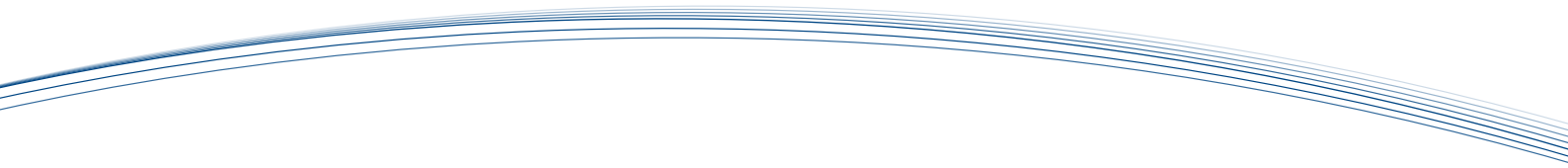

pure
perfection

Know-How-Transfer

- Up-To-Date Knowledge

Software
Training, seminars and workshops
Consulting and calculations
Literature and documentations



***Goal-oriented and of practical
benefit for the user***

K

General Information

The right software makes work easier. FRENCO offers two software packages, which assist in handling and designing of splines:

FRENCO GmbH
Jakob-Baier-Straße 3
90518 Altdorf
Tel.: +49 (0) 9187/9522-0
Fax.: +49 (0) 9187/9522-40
E-Mail: frenco@frenco.de

Please visit our homepage www.frenco.de where you will find additional information on our software packages and demo versions.

Spline Standards



Standard-compliant design of spline profiles

Spline Calculator



To calculate the spline data and inspection dimensions of spline profiles with involute flanks and serration flanks

Software Spline Standards

Design of spline profiles

Data from the following spline standards [DIN 5480](#) (Germany), [ANSI B92.1](#) (USA), [ISO 4156](#) (International) is included in the Software Spline Standards. Spline profiles can be designed similar to the standard or manually as required.

Main menu

Toolbar for a quick access to all functions

Clearly arranged input mask

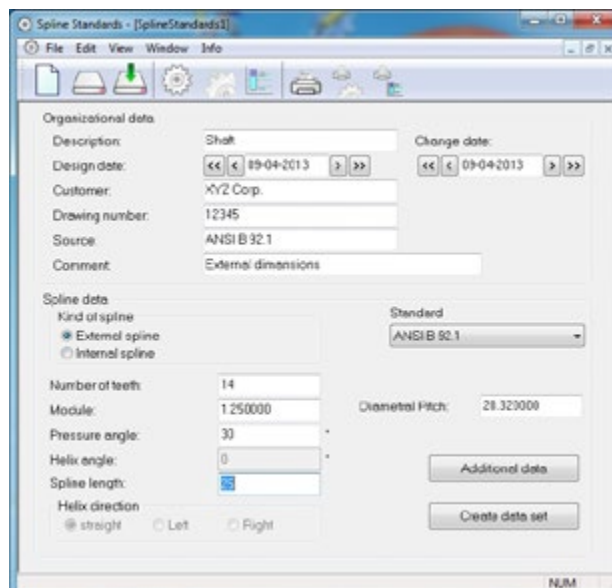

Selection via drop down menu

- DIN 5480
- DIN 5480 similar
- ANSI B 92.1
- ANSI B 92.1 similar
- ISO 4156
- ISO 4156 similar
- Free input



Manual entry

The manual entry allows for the required spline data to be entered independent of any standard. The tolerances can be in accordance with the standard, as and when required.

DIN 5480
 DIN 5480 similar
 ANSI B 92.1
 ANSI B 92.1 similar
 ISO 4156
 ISO 4156 similar
Free input

Design in accordance with the relevant standard

If a spline is designed in accordance with, e.g. DIN 5480, a simplified dialog box opens.

DIN 5480
 DIN 5480 similar
 ANSI B 92.1
 ANSI B 92.1 similar
 ISO 4156
 ISO 4156 similar
 Free input

Generation of data set

Once the spline data has been entered, a dataset will be created which includes all entered and calculated data

It is also possible to graphically display the entire spline profile the spline shape (with or without measuring circle) and the tolerance zone.

Kind of spline:	External spline	Major diameter DDE:	18.7500	OK	
Number of teeth:	14	Tolerance DDE:	0.0000	Print	
Module:	1.25000	Form diameter DFE:	16.4400		
Diametral Pitch:	20.32000	Minor diameter DDE:	16.2500		
Pressure angle:	30.0000	Tolerance DFE:	0.0000		
Pitch circle diameter:	17.5000	Max effective SV:	2.0360		
Base circle diameter:	15.1554	Max actual SMAK:	2.0160		
Helix angle:	0.0000	Min actual SMIN:	1.9800		
Helix direction:	straight	Major diameter DDE:	2.2500	Change pitch diameter	
Spline length:	25.0000	Minor MRE EFF:	20.8777	Total profile deviation:	11.0
Standard:	DIN 5480 similar	MRE MAK:	20.0479	Lead deviation:	11.0
Reference diameter:	—	MRE MIN:	20.7933	Runout deviation:	—
Tolerance class:	3	Tolerance MRE:	0.0543	Total pitch deviation:	36.0
Tolerance location:	—			Single addendum:	11.0
Fit:	Side fit				
Roughness:	Flat root				

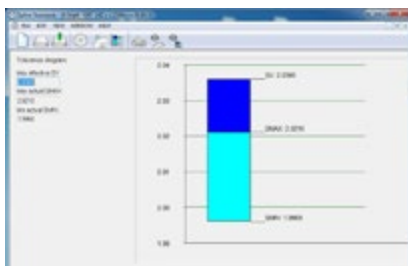

tolerance zone

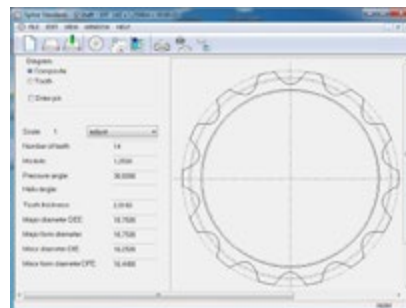

spline profile

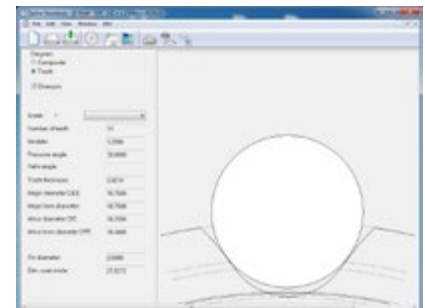

spline shape



Software Spline Calculator

Calculating the spline data and inspection dimensions

The Spline Calculator software allows for a quick and uncomplicated calculation of the spline data and inspection dimensions of internal and external...

...cylindrical splines with serrated flanks

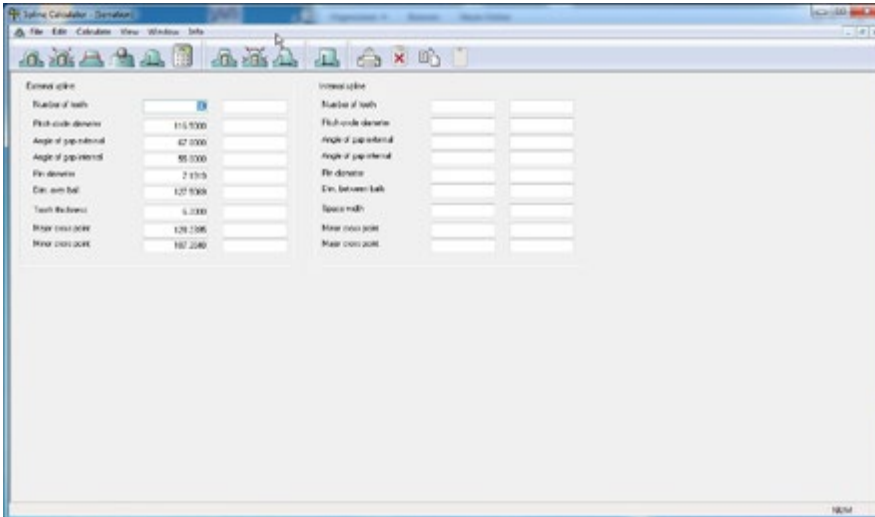

...cylindrical splines with involute flanks

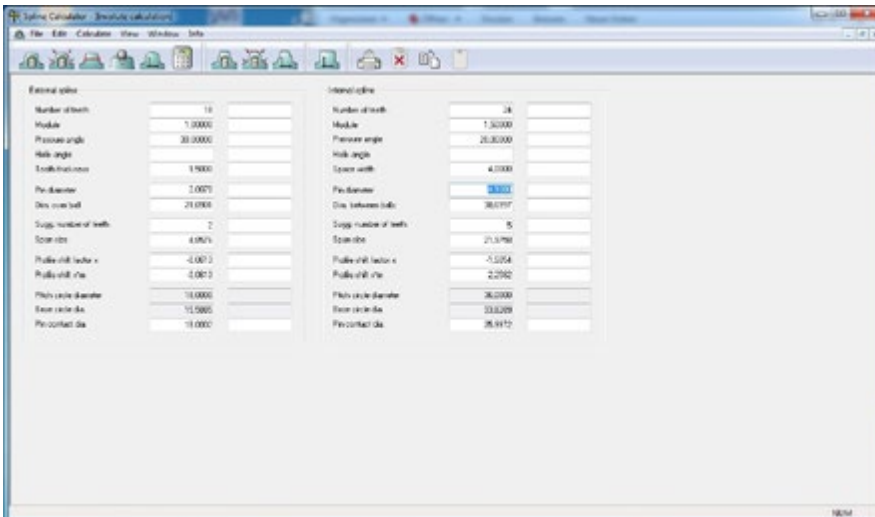

The software can be used to convert inspection dimensions, which may be given in various shapes and forms, into other parameters. The number of teeth, module, helix and pressure angle parameters are used to automatically calculate all other parameters, which can be subsequently modified, such as dimension over measuring circle, tooth thickness etc.



The gear profile can be displayed, as is the case with the Spline Standards Software, with or without measuring circle. Any required measuring circle flats are calculated automatically.

The Spline Calculator is a hands-on tool to slowly approach the required tooth shape and the most suitable measuring circle. Any modifications are immediately displayed in the diagram.

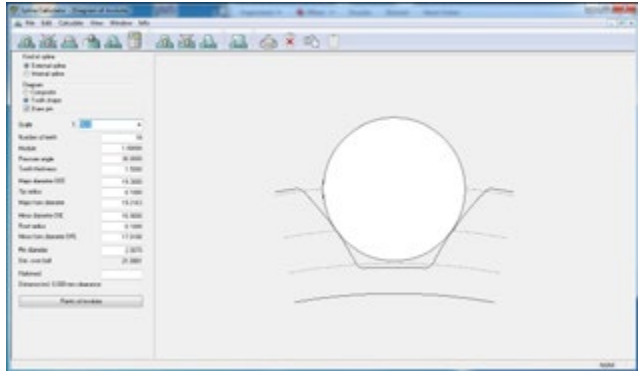
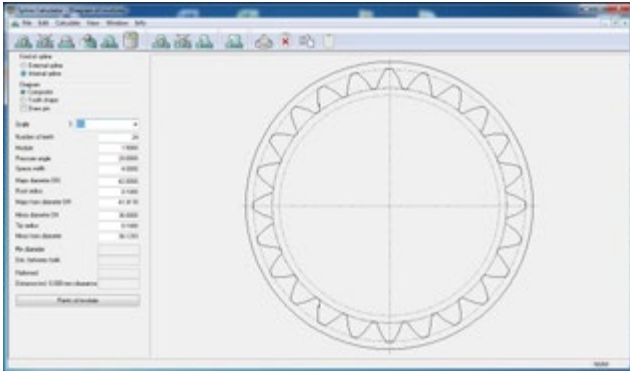

For CAD systems, up to 100 involute points can be calculated for a flank and saved as a text file. This makes it easier to draw up gearing profiles in CAD.

No.	Left	Right
1	1.9793, 17.9559	-1.9792, 17.9559
2	1.7960, 19.5567	-1.7967, 19.5567
3	1.5885, 19.1591	-1.5884, 19.1591
4	1.2688, 19.7605	-1.2687, 19.7605
5	0.9303, 20.3588	-0.9302, 20.3588
6	0.5448, 20.9518	-0.5447, 20.9518

The Spline Calculator also includes calculation bases ...
... for fillet radii and full fillets

... and special calculations such as rolling lengths and rolling angle.

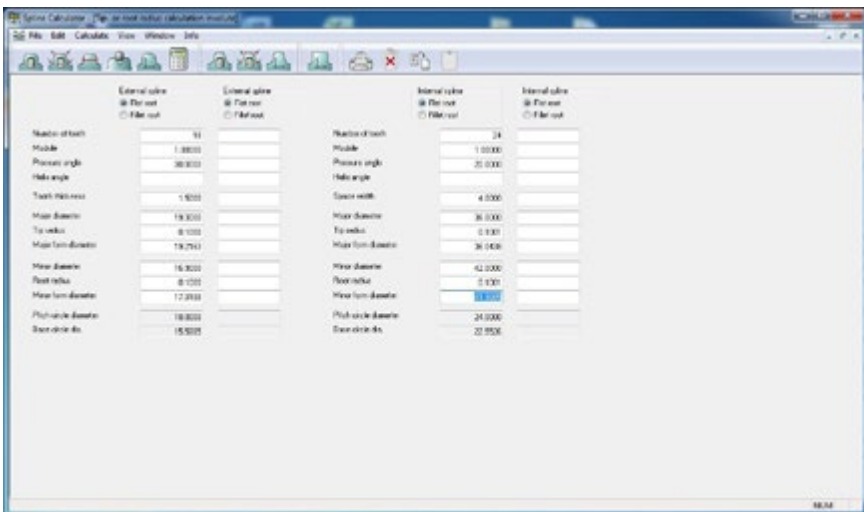

K

Training, Seminars and Workshops

It is difficult to fully understand the complex field of gears and splines. Even specialists will only be proficient in certain parts. FRENCO has a unique set of experience at its disposal, by having consistently focussed on gear and spline production metrology for more than 30 years.

Ongoing development and intensive standardisation work ensure that this knowledge keeps on growing. Wherever possible, this knowledge is passed on.

FRENCO offer various training programs on gearing. They are held in cooperation with the TAW (Technical Academy Wuppertal) at their training facilities.

It is also possible to hold certain training programs on-site at the customers' premises.

More detailed information on the respective training programs can be found in our brochure KS and on our website www.frenco.de.

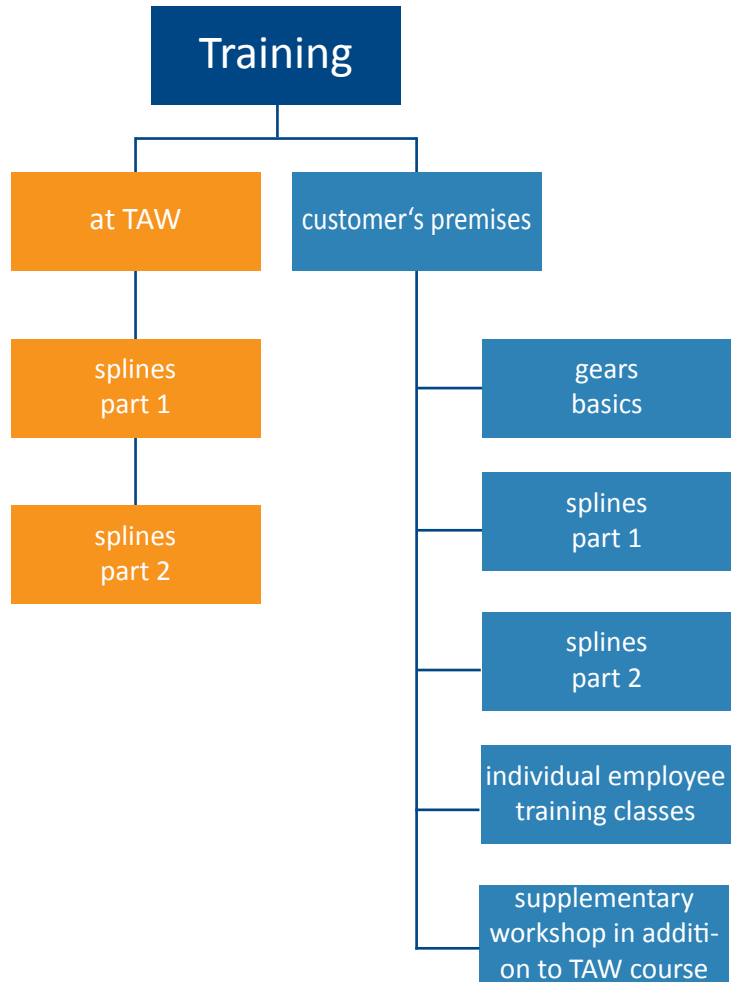

Splines are a technical fringe subject and are not included in any syllabus for engineering sciences. There are lectures at universities and complex literature available on running gears like cylindrical gears, bevel gears and worm gears. There are spline standards but there is not even a single book on splines. Frenco offer a wide range of documentation on splines, plus relevant seminars.

The spline seminars (part 1 and 2) are held over 2 days, either at the TAW training facilities in Altdorf, or, on request, on-site at your premises.

To register and for more information on these seminars, please visit www.taw.de



Spline Seminars

Basics:

1. Spline geometry
2. The classification of spline fits
3. Tolerance limits actual and effective
4. Workpiece representation on drawings
5. Summary of current spline standards

Quality Assurance:

1. Short recap of the basics
2. Summary of quality features
3. Inspection method of the size ,actual'
4. Inspection method of the size ,effective'
5. Effity
6. Inspection of individual deviations
7. Inspection of positional deviations

Additional Workshop at the Customer's Premises

Practical application of splines in your area

Example of topics:

1. Process capability
2. Spline gauge technology
3. Circumferential backlash measuring systems
4. Profiled clamping systems
5. Working with gear and spline standards
6. Design of splines without adhering to any standard
7. The position of the spline axis



Customised Training Courses

FRENCO also offer training programs at your premises on subjects that are currently relevant to you.

Example of topics:

1. Introduction to splines for newcomers
2. Increasing existing knowledge
3. Corrections of existing drawings, design of your parts
4. Monitoring of inspection equipment, training on pin dimension inspection



Gear Seminar

This seminar is aimed at technicians and engineers who want to get a basic understanding of gears. It assumes some general knowledge of the metal working industry.

Basics:

1. Various types of gearing
2. The involute as a flank form
3. Spur gear pair
4. Spur gears
5. Summary of quality features
6. Inspection of the actual size
7. Rolling inspection
8. Inspection of individual deviations
9. Inspection of positional deviations



K

pure
perfection

Support

Frenco's specialists offer their help for a range of different problems.



Creation and revision of gear and spline standards:



Gear and spline measuring equipment evaluations

Tolerancing of drawings
 Inspection plans
 Measurement uncertainties

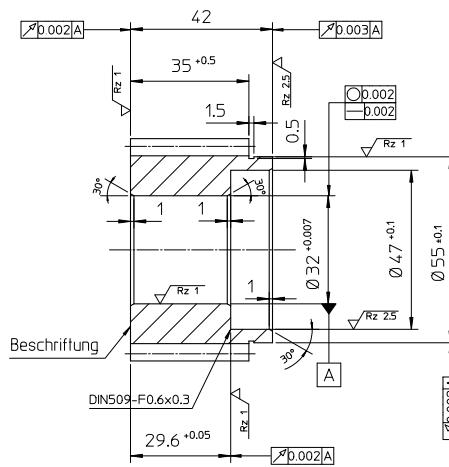

Solving measuring tasks with specific problems

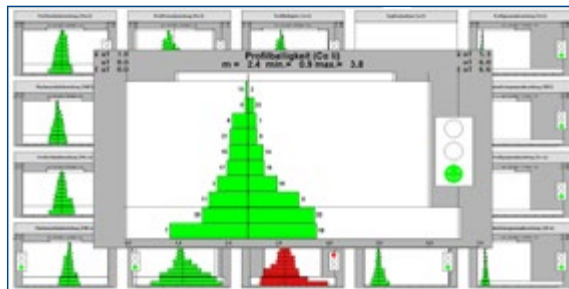

Research into basic principles
 Research assignments
 Practical implementation of ideas



Calculation

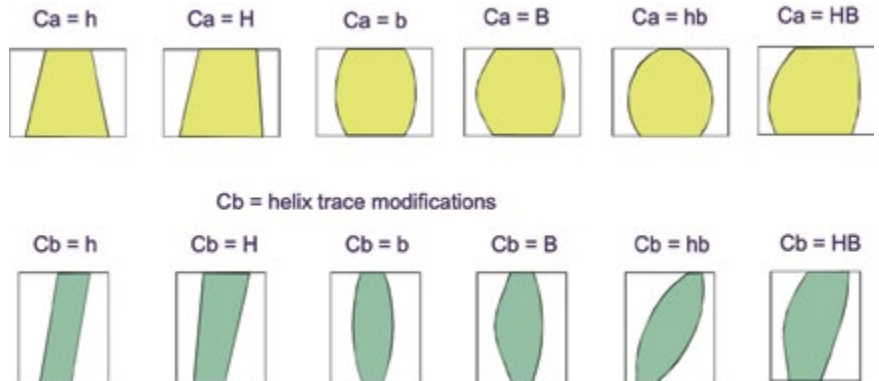

Profile modifications

Profile modifications for shrinking and forming processes ISO data formats for NC machines DFX-files

Gear design

Lehrzahnrad		m374 - m24* - z26 - BW/271 - G4 - 08/0970	
Teilenummer	1	Lehrzahnrad	111 501 5 8748
Material	18	Zahnrad	101 5 5488
Modul / DP	2,7489	Modul über Außen	401 118 3251
Engagement	34,8888*	Zahnrad	101 5 5158
Schneckenpaar	54,4888*	Modul über Außen	401 118 4883
Schneckenpaar	1,1888		
Lehrzahnrad	101 5 5154		
Zahnrad	101 5 5175	Lehrzahnrad	101 5 5152
		Zahnrad	101 5 5153
		Lehrzahnrad	101 5 5154
		Zahnrad	101 5 5155
		Lehrzahnrad	101 5 5156
		Zahnrad	101 5 5157
		Lehrzahnrad	101 5 5158
		Zahnrad	101 5 5159
		Lehrzahnrad	101 5 5160
		Zahnrad	101 5 5161
		Lehrzahnrad	101 5 5162
		Zahnrad	101 5 5163
		Lehrzahnrad	101 5 5164
		Zahnrad	101 5 5165
		Lehrzahnrad	101 5 5166
		Zahnrad	101 5 5167
		Lehrzahnrad	101 5 5168
		Zahnrad	101 5 5169
		Lehrzahnrad	101 5 5170
		Zahnrad	101 5 5171
		Lehrzahnrad	101 5 5172
		Zahnrad	101 5 5173
		Lehrzahnrad	101 5 5174
		Zahnrad	101 5 5175
		Lehrzahnrad	101 5 5176
		Zahnrad	101 5 5177
		Lehrzahnrad	101 5 5178
		Zahnrad	101 5 5179
		Lehrzahnrad	101 5 5180
		Zahnrad	101 5 5181
		Lehrzahnrad	101 5 5182
		Zahnrad	101 5 5183
		Lehrzahnrad	101 5 5184
		Zahnrad	101 5 5185
		Lehrzahnrad	101 5 5186
		Zahnrad	101 5 5187
		Lehrzahnrad	101 5 5188
		Zahnrad	101 5 5189
		Lehrzahnrad	101 5 5190
		Zahnrad	101 5 5191
		Lehrzahnrad	101 5 5192
		Zahnrad	101 5 5193
		Lehrzahnrad	101 5 5194
		Zahnrad	101 5 5195
		Lehrzahnrad	101 5 5196
		Zahnrad	101 5 5197
		Lehrzahnrad	101 5 5198
		Zahnrad	101 5 5199
		Lehrzahnrad	101 5 5200
		Zahnrad	101 5 5201
		Lehrzahnrad	101 5 5202
		Zahnrad	101 5 5203
		Lehrzahnrad	101 5 5204
		Zahnrad	101 5 5205
		Lehrzahnrad	101 5 5206
		Zahnrad	101 5 5207
		Lehrzahnrad	101 5 5208
		Zahnrad	101 5 5209
		Lehrzahnrad	101 5 5210
		Zahnrad	101 5 5211
		Lehrzahnrad	101 5 5212
		Zahnrad	101 5 5213
		Lehrzahnrad	101 5 5214
		Zahnrad	101 5 5215
		Lehrzahnrad	101 5 5216
		Zahnrad	101 5 5217
		Lehrzahnrad	101 5 5218
		Zahnrad	101 5 5219
		Lehrzahnrad	101 5 5220
		Zahnrad	101 5 5221
		Lehrzahnrad	101 5 5222
		Zahnrad	101 5 5223
		Lehrzahnrad	101 5 5224
		Zahnrad	101 5 5225
		Lehrzahnrad	101 5 5226
		Zahnrad	101 5 5227
		Lehrzahnrad	101 5 5228
		Zahnrad	101 5 5229
		Lehrzahnrad	101 5 5230
		Zahnrad	101 5 5231
		Lehrzahnrad	101 5 5232
		Zahnrad	101 5 5233
		Lehrzahnrad	101 5 5234
		Zahnrad	101 5 5235
		Lehrzahnrad	101 5 5236
		Zahnrad	101 5 5237
		Lehrzahnrad	101 5 5238
		Zahnrad	101 5 5239
		Lehrzahnrad	101 5 5240
		Zahnrad	101 5 5241
		Lehrzahnrad	101 5 5242
		Zahnrad	101 5 5243
		Lehrzahnrad	101 5 5244
		Zahnrad	101 5 5245
		Lehrzahnrad	101 5 5246
		Zahnrad	101 5 5247
		Lehrzahnrad	101 5 5248
		Zahnrad	101 5 5249
		Lehrzahnrad	101 5 5250
		Zahnrad	101 5 5251
		Lehrzahnrad	101 5 5252
		Zahnrad	101 5 5253
		Lehrzahnrad	101 5 5254
		Zahnrad	101 5 5255
		Lehrzahnrad	101 5 5256
		Zahnrad	101 5 5257
		Lehrzahnrad	101 5 5258
		Zahnrad	101 5 5259
		Lehrzahnrad	101 5 5260
		Zahnrad	101 5 5261
		Lehrzahnrad	101 5 5262
		Zahnrad	101 5 5263
		Lehrzahnrad	101 5 5264
		Zahnrad	101 5 5265
		Lehrzahnrad	101 5 5266
		Zahnrad	101 5 5267
		Lehrzahnrad	101 5 5268
		Zahnrad	101 5 5269
		Lehrzahnrad	101 5 5270
		Zahnrad	101 5 5271
		Lehrzahnrad	101 5 5272
		Zahnrad	101 5 5273
		Lehrzahnrad	101 5 5274
		Zahnrad	101 5 5275
		Lehrzahnrad	101 5 5276
		Zahnrad	101 5 5277
		Lehrzahnrad	101 5 5278
		Zahnrad	101 5 5279
		Lehrzahnrad	101 5 5280
		Zahnrad	101 5 5281
		Lehrzahnrad	101 5 5282
		Zahnrad	101 5 5283
		Lehrzahnrad	101 5 5284
		Zahnrad	101 5 5285
		Lehrzahnrad	101 5 5286
		Zahnrad	101 5 5287
		Lehrzahnrad	101 5 5288
		Zahnrad	101 5 5289
		Lehrzahnrad	101 5 5290
		Zahnrad	101 5 5291
		Lehrzahnrad	101 5 5292
		Zahnrad	101 5 5293
		Lehrzahnrad	101 5 5294
		Zahnrad	101 5 5295
		Lehrzahnrad	101 5 5296
		Zahnrad	101 5 5297
		Lehrzahnrad	101 5 5298
		Zahnrad	101 5 5299
		Lehrzahnrad	101 5 5300

3D gear design

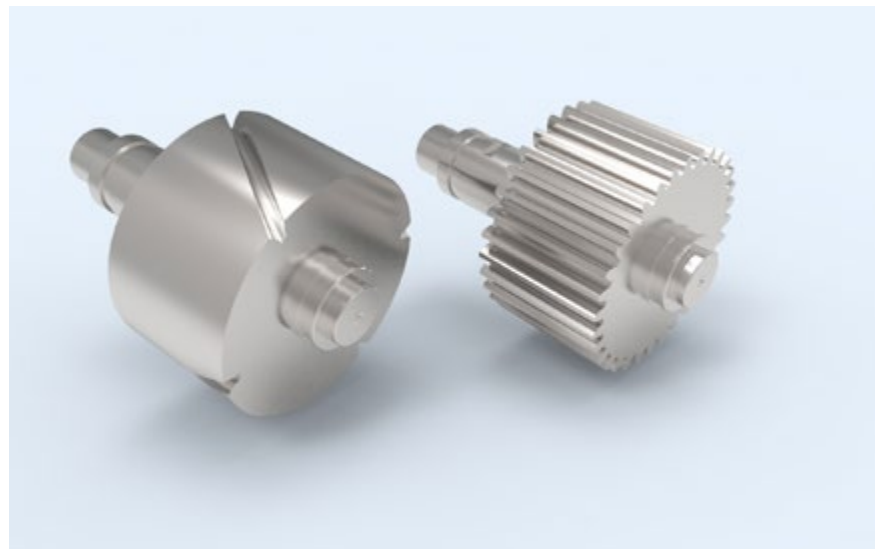

pure perfection

OF Documentations

The OF documentation includes knowledge transfer of gears and splines, simple explanations, no longer available standards and educational games. They are, at the same time, the only spline literature that is available other than spline standards.

FRENCO books:	Summary of documents on one issue
OFL literature:	Easy understanding explanations of known knowledge
OFS descriptions:	Explanations of technical correlations
OFD definitions:	Definitions of not general proven correlations

For prices see the current single brochure KD.

FRENCO Books

Volume 1	Splines Quality assurance 154 pages <i>item no. KD-0101</i>	<ol style="list-style-type: none"> Gears and splines (former OFL 01) Quality assurance of splines overview (former OFS 10) Inspection of splines with measuring machines (former OFD 13) Control of manufacturing process (former OFS 01) Actual and effective inspection methods (former OFS 04) Actual and effective inspection instruments (former OFS 05) Effective fit clearance (former OFS 03) Effective backlash tolerance limit (former OFS 18) One flank taper masters (former OFD 03) Helical Splines (former OFS 14)
Volume 2	Splines The position of the spline axis 106 pages <i>item no. KD-0102</i>	<ol style="list-style-type: none"> Tolerances of location (former OFD 01 and OFS 06) Clamping systems for splines (former HWS-T) Variation of angularities (former OFD 04)
Volume 3	Splines Standards and Calculation 122 pages <i>item no. KD-0103</i>	<ol style="list-style-type: none"> List of standards (former OFS 24) Summary of spline standards (former OFS 13) Explanation of spline standards (former OFL 03) Spline design without use of standards (former OFL 02)
Volume 4	Gears* Quality assurance 178 pages <i>item no. KD-0104</i>	<ol style="list-style-type: none"> Gear train (former OFS 19) Dimensions and tolerances (former OFS 20) The evolvent (former OFS 17) History of gear measurement (OFS 2) Rolling Inspection (OFS 09) Inspection of individual deviation (OFS 11) Deviation analysis (former OFS 12) Different measurement methods – different results (OFD 12)

*These documents have not yet been translated into English. If they are ordered, delivery might be a little delayed.



OFL Literature

Only available in above mentioned books:

order no	subject	title	included in book
OFL 01	Involute splines	Quality assurance	Volume 1
OFL 02	Splines	Spline design without use of standards	Volume 3
OFL 03	Splines	Explanation of spline standards	Volume 3
OFL 06	Gears and Splines	Formulas inspection dimensions	Volume 3

Available as separate documents:

order no	subject	title	pages	version
OFL 05	Involute Splines	Inspection Rules for metrology instruments 1. Statistical tolerance limit STA 2. Spline gauges 3. Spline gauge ring with one flank master plug gauge 4. Profiled setting master 5. Master gears 6. One flank taper arbor 7. Variable 3-disc indicating gauge 8. Runout inspection	67	01/15
OFL 07	Splines	USA Standard ANSI B 92.1 - 1970 soft metric version	154	1970
OFL 07-1	Splines	USA Standard ANSI B 92.1 Changes in 1996 edition	8	1997
OFL 08	Splines	USA Standard ANSI B 92.2 M	254	1989

K

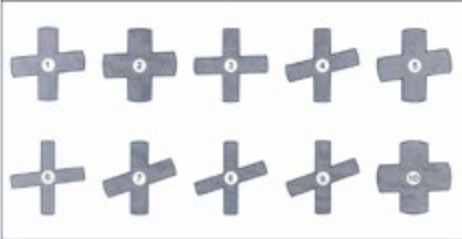
order no	subject	title	pages	version
OFL 11	Splines and Gear	Dictionary German-English English-German	66	01/15
OFL 12	Splines and Gear	Dictionary German-English-Italian	28	03/15
OFL 13	Involute Serrations	JIS B 1602 – 1961 Japanese Standard	22	1961
OFL 14	Involute Splines	JIS D 2001 – 1959 Japanese Standard	40	1959
OFL 15	Metrology of gears and splines	FRENCO – pedia Encyclopaedia of metrology	40	05/13
OFL 16	Splines	Manual for Technicians	109	03/08
OFL 17	Splines	Effity Educational game to learn about and understand splines within the tolerance chart. 10 sample parts, 6 measuring instruments and a coloured instruction manual.  		2005
OFL 17-1	Splines	Effity , separate instructions	36	2005

OFS Descriptions

Only available in above mentioned books:

order no	subject	title	included in book
OFS 01	Splines	Control of manufacturing process	Volume 1
OFS 02	Gears and Splines	History of gear artefacts	Volume 4
OFS 04	Splines	Actual and effective inspection methods	Volume 3
OFS 05	Splines	Actual and effective inspection instruments	Volume 1
OFS 06	Gears and splines	Methods of determining the axis of spline and gear	Volume 2
OFS 09	Gears	Gear rolling inspection	Volume 4
OFS 10	Gears and splines	Quality assurance of gears and splines	Volume 4
OFS 11	Gears and splines	Analytical inspection	Volume 4
OFS 12	Gears and splines	Deviation analysis	Volume 4
OFS 13	Splines	Summary of spline standards	Volume 3
OFS 14	Splines	Helical splines	Volume 1
OFS 17	Gears and splines	The involute, simple explanation	Volume 4
OFS 18	Splines	Effective backlash tolerance limit	Volume 1
OFS 19	Gears	Mating gears, rolling condition, revolutions, center distance, profile shift	Volume 4
OFS 20	Gears	Deviation of size, tolerances, ranges of quality	Volume 4
OFS 24	Splines	Listing of standards	Volume 3
OFS 25	Splines	The position of the spline axis	Volume 3
OFS 26	Splines	Inspection of splines	Volume 1

Available as separate documents:

order no	subject	title	pages	version
OFS 03	Splines	Effective fit clearance	12	08/99
OFS 15	Gears and splines	Various types of gears and splines	8	02/05
OFS 23	Gears and splines	Production methods	20	01/06
OFS 28	Splines	Splines with serrations Calculation	78	03/10
OFS 29	Gears	Quality assurance Reading of semicolon-analysis	28	03/10
OFS 30	Gears	Quality assurance Presentation forms of gear deviations	20	04/11

OFD Definitions

Only available in above mentioned books:

order no	subject	title	included in book
OFD 01	Splines	Spline tolerances of location	Volume 2
OFD 03	Spline gages	One flank taper masters	Volume 1
OFD 04	Splines	Spline variations of angularity	Volume 2
OFD 12	The dimension tooth thickness	Various measuring methods	Volume 4
OFD 13	Splines	Inspection of splines by the use of inspection machines	Volume 1

Available as separate documents:

order no	subject	title	pages	version
OFD 10	Gear and spline high precision	Acceptance or rejection of gauges and masters with regard to the tolerance limits of size and form variations	24	03/12
OFD 11	Tolerance limits	Acceptance or rejection of specimen with regard to tolerance limits (ISO 14253)	20	11/12



FRENCO

Frenco GmbH
Gear + Spline Technology

Jakob-Baier-Straße 3
D - 90518 Altdorf

Tel.: +49 (0) 9187 - 95 22 0
Fax: +49 (0) 9187 - 95 22 40
E-Mail: frenco@frenco.de

